



Construction Industry



Claw Couplings



Complete Screwing Sets, etc.



Mortar Couplings and Plugs



Sandblast Couplings



Hose Clamps and Hose Clips



Ball Valves and Throttle Valves



Table of Contents

Construction Industry

202	General Information
204	Top Quality for Safe Working
205	Assembly of Hoses and Fittings

Claw Couplings

206	Product Information
208	Product Overview
210	Standards for Claw Couplings
211	Claw Couplings Standard Version DIN 3489
213	Claw Couplings Swivelling DIN 3489
214	Claw Couplings MODY-Safety-Screwing Couplings DIN 3238
216	Claw Couplings with Brass Seal
217	Claw Couplings with Bore for Safety-Clips
218	Claw Couplings Left-Closing and Coloured
219	Claw Couplings made of Hardened Steel
220	Claw Couplings made of Forged Brass MS 58
221	Claw Couplings US-Version with Bore for Safety-Clips
222	Claw Couplings US-Version with Bore for Safety-Clips - MODY-Safety-Screwing Couplings

Complete Screwing Sets, FlatLock Flat Hose Screwings, Connecting Nipples, Hose Connections

224	Product Information
226	Product Overview
227	Complete Screwing Sets with Hose Stem
228	Complete Screwing Sets - Connecting Nuts and Tapered Stems
230	Complete Screwing Sets with Male Thread
231	Complete Screwing Sets, Flat Sealing
231	Double Nipples, Flat Sealing
232	Flat Hose Screwings (FlatLock by LUDECKE)
234	Connecting Nipples
235	Hot Tar Screwings
236	Thread Stems
237	Hose Connections and Thread Ferrule Screwings

Table of Contents

Construction Industry

Mortar Couplings and Plugs

Product Information	238
Product Overview	239
Mortar Couplings made of Malleable Iron/ Steel - Standard Version	240
Mortar Plugs made of Malleable Iron/ Steel - Standard Version	242
Mortar Couplings and Plugs made of Malleable Iron/ Steel - for Hydraulic Hose Crimping	244
Mortar Couplings made of Aluminium	246
Mortar Couplings made of Malleable Iron/ Steel - Interchangeable with System "Mai"	247



Sandblast Couplings

Product Information	248
Product Overview	249
Sandblast Couplings and Nozzle Holders made of Malleable Iron/ Aluminium	250
Sandblast Couplings and Nozzle Holders made of Nylon	251
Sandblast Throttle Valve	251



Hose Clamps and Hose Clips

Product Information	252
Product Overview	252
Hose Clamps - Standard-Version	253
Hose Clamps - US-Version	254
Double-Ear Hose Clips	254



Ball Valves and Throttle Valves

Product Information	255
Product Overview	255
Ball Valves - Sturdy Version	256
Ball Valves - Light Version	256
Double Ball Valves and Airhammer Ball Valves - Sturdy Version	257
Throttle Valves - Standard Version	258
Throttle Valves - US-Version	259



Robust Coupling Systems for Outdoor Applications at Construction Sites



Whether in classic construction, mining and tunnelling, ship yards, petrochemical industry, agriculture or in gardening and landscaping: In these areas, reliable coupling systems are required which withstand extreme use and weather conditions.

The **LUDECKE** construction product portfolio offers high-quality and robust products - optimised for a number of challenging applications and different media.

Advantages:

- First-class and especially solid materials
- Safe, reliable and durable
- Simple and intuitive handling
- Different sizes and connection types
- From standard range to individual solutions and customised hose assemblies

Quality and Service



Engineered and Made in Germany - with this promise we do not only guarantee excellent products but also a comprehensive customer service.

On the following pages, we will give you an insight on how important it is to choose high-quality couplings and fittings in this area.

Avoid unnecessary safety risks with the **LUDECKE** construction range which has been tested and meets the DIN standards (page 204). Take the chance and have **LUDECKE** customise your products for the hose you want (page 205).

Lifetime-Guarantee: Original **LUDECKE** Claw Couplings and Clamps made of malleable iron from the 60s still used today in pneumatic demolition hammers

Materials

For all products, **LUDECKE** only uses premium materials which are customised to the application.

Malleable iron

Most of the **LUDECKE** construction fittings are made of malleable cast iron. This material has perfect mechanical properties (e.g. high tensile strength) which prevent brittle fractures when subject to excess strain. As a result, malleable cast iron is perfect for applications in which the components are exposed to strong dynamic stress (e.g. vibrations) and high mechanical forces. **LUDECKE** only works with galvanised and yellow passivated malleable cast iron (free of chrome VI) in accordance with the RoHS guideline.

Steel (Hardened/ Nickel-Plated/ Zinc-Plated)

If products are used under tough conditions (i.e. in foundries), they need to be manufactured out of machining steel (hardened, nickel-plated or zinc-plated). This material has good case-hardening properties and a long lifetime.

Aluminium

Products made of aluminium impress with their very low weight (up to 60% weight reduction). This makes them much easier to handle when in continuous operation. Aluminium is resistant to corrosion as well as chemical media and is ideally suited for machining.

Brass (Plain/ Nickel-Plated)

The material brass MS 58 (machining brass) is a very sturdy material which guarantees high durability and is perfectly suited for galvanisation (nickel, chrome). In the construction sector, this material is applied for complementary products (e.g. locking nuts).

Stainless Steel

In areas with specific hygiene standards or when conveying various difficult media, quick connect couplings made of stainless steel are required. For further information, please refer to our program for the processing industry.

Seals

Depending on the requirements, **LUDECKE** offers various types of high-quality sealings made of NBR, brass, PTFE and PUR.

Broad Range

From classic claw couplings, mortar couplings and sandblast couplings to hose clamps and throttle valves: At **LUDECKE** you will surely find the right product for a wide range of applications.



Top Quality for Safe Working

High-Risk Potential Caused by Inferior Material



Fracture test - left: **LUDECKE** hose clamp (no crack/ fracture), right: hose clamp from the Far East (complete fracture)

Again and again, you will find cheap copies of claw couplings and their matching hose clamps on the market. They are mostly manufactured in the Far East.

Lack of functionality

However, using such products comes with a high-risk potential: On the one hand, many cast components have great tolerances. Often, the couplings can no longer be tightly connected and or lead to leakages. Moreover, due to the improperly casted hose barbs and high tolerances of the clamps, a safe fitting of a hose cannot be guaranteed!

High Potential of Fractures

As these copies are often produced with low-quality and non-approved materials such as chilled cast iron (white iron), the products may easily fracture under high strain (i.e. when installed in strongly vibrating construction machines with compressed air).

Using such unsuitable products poses a high liability risk!

Safety with High-Quality and Standardised Components

To avoid these great safety risks, pay attention to the following:

- White iron and other inferior materials are hard and very brittle due to their high amount of cementite steel. As a result, they are inappropriate materials for high stress applications
- The production of malleable cast iron is more time-consuming and expensive as it undergoes an additional annealing treatment. However, this provides malleable cast iron with enhanced mechanical properties and makes it perfect for extreme conditions.
- Only components should be sold and used which follow the current standards (DIN 3489, DIN 3238, DIN 20039) and show the obligatory manufacturer's branding.



Original **LUDECKE** Claw Coupling according to DIN 3489



Counterfeit from the Far East (no manufacturer's branding, inferior material)

The products of the **LUDECKE** construction range undergo continuous, strict quality tests. In this way, we always guarantee high reliability for permanent use.

Assembly of Hoses and Fittings

It is all about the perfect connection

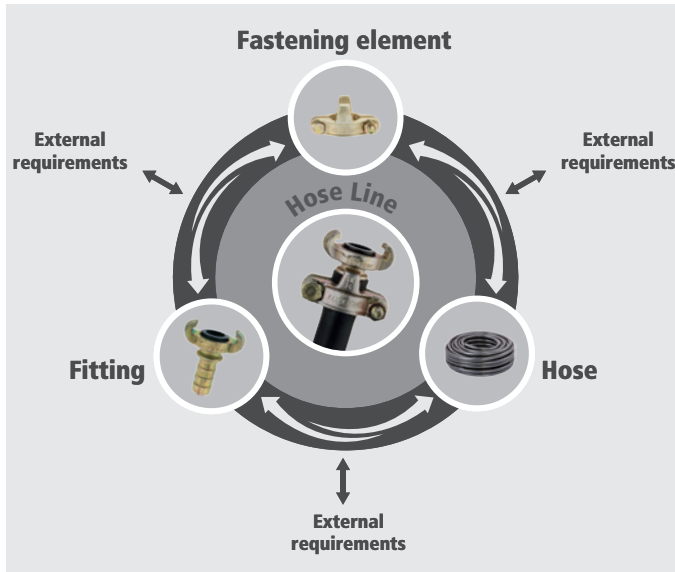

High-quality couplings and fittings are essential for reliable and safe operation. However, long-term and satisfying results are only achieved, when all components of a hose line interact perfectly.

Problems when assembling fittings on hoses:

There are a number of hose manufacturers which often offer different materials and dimensions for identical hose sizes and purposes due to missing standards.

Then there are the fittings manufacturers. They produce diverse fittings for standard hose sizes and use different assembly methods. These fittings have also dimensional tolerances just as the hoses. This is why barb contours from various manufacturers can vary in form and dimension.

General Statements are not always Possible

Assembled hose lines often act very differently under pressure and temperature. Depending on the application, this will hamper a secure connection between hose and fitting.

Moreover, the requirements hose lines have to meet are continuously increasing with regards to resistance to operating pressures, ambient and operating temperature, chemical substances and external mechanical strain.

Due to the variety of impacting parameters, it is not possible to make a generalised statement about the reliability of hose assemblies based on their individual components.

Professional Hose Assemblies with **LUDECKE**



Based on the desired hose type, **LUDECKE** helps to select the right fitting and assembly method.

All hose assemblies are also tested in our own test centre using a wide range of criteria.

Our specially trained experts (persons qualified to test hose assemblies in accordance to German law § 2 Para. 6 BetrSichV) can make reliable statements about their suitability for the applications and media in question.

If you cannot find a properly sized fitting for your hose, we will be happy to produce a customised solution.

Claw Couplings



The **LUDECKE** claw coupling is the system which is applied world-wide for compressed air supply in construction and industry.

Malleable cast iron is the only material we use in this manufacturing process (exception: stainless steel for critical media). Due to its heat treatment, this cast material guarantees the required elasticity especially for thin walled parts and is the mandatory material according to DIN 3489 and DIN 3238.

The **LUDECKE** claw coupling range consists of different versions and offers numerous application possibilities.

Advantages:

- High-quality materials
- Very robust and durable
- Simple and fast handling
- Identical coupling head: connection versions and sealing systems can be connected with each other
- Maximum bore for maximum flow
- Increased safety with MODY-Safety-Screwing-Couplings and claw couplings with safety collar
- Different connection and thread types

A Reliable Classic

The success story of **LUDECKE** started with the claw coupling. To this day, this product is characterized by reliability, safety and excellent quality.



The Coupling Concept: Simply Brilliant

Push the two couplings together at 180° degrees opposite to each other until the seal faces touch. Afterwards, rotate one coupling half as far as it will go into the opposite direction of the other - the couplings lock into place.



To disconnect, push the coupling and the counterpart together in axial direction. Afterwards, turn one coupling half as far as possible in the opposite direction as you would do when connecting and remove it from the counterpart.

Maximum Safety

Operator and machine safety is always our top priority. This is why we offer our claw couplings with two safety functions.

MODY-Safety-Screwing Coupling DIN 3238

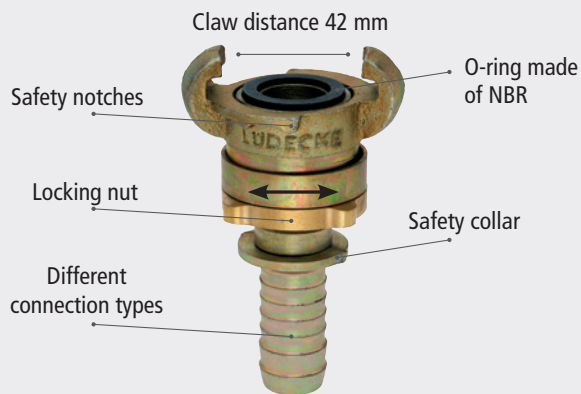

To ensure a perfect connection, we recommend to take the MODY-safety-screwing coupling. It has a locking nut which is tightened manually and prevents the coupling halves from loosening.

In general, we recommend to always choose a classic claw coupling with a MODY-safety-screwing coupling. This connection is absolutely safe, easy to connect and 100 % leakage-proof.

Claw Couplings with Safety Collar



Many **LUDECKE** claw couplings are available with an optional safety collar. Special hose clamps allow for a reliable and technically correct assembly of the hose to the coupling. The hose clamps have safety claws which hook firmly into the safety collar. This prevents unintended slipping or loosening of the hose. The safety claws also ensure that the hose clamps are attached to the hose stems with the correct spacing - incorrect installation can be eliminated.

Overview of Claw Couplings

also in Stainless Steel

Standard

DIN 3489



Swivelling

DIN 3489



also in Stainless Steel

MODY-Safety-Screwing Coupling

DIN 3238



With Brass Seal



Materials

Claw:	Malleable iron (zinc-plated + yellow passivated)	Malleable iron (zinc-plated + yellow passivated)	Malleable iron (zinc-plated + yellow passivated)	Malleable iron (zinc-plated + yellow passivated)
Connector:	Malleable iron (zinc-plated + yellow passivated)	Steel (zinc-plated + yellow passivated)	Steel (zinc-plated + yellow passivated)	Malleable iron (zinc-plated + yellow passivated)
Locking nut:	-	-	MS 58 plain	-
Screw:	-	-	-	Steel (zinc-plated + yellow passivated)
Seals:	NBR	NBR	NBR, Brass	Brass
Special seals on request:	TFEP, FKM, EPDM	TFEP, FKM, EPDM	TFEP, FKM, EPDM	TFEP, FKM, EPDM
Max. Working Pressure:	PN 10 bar	PN 16 bar	PN 16 bar	PN 10 bar
Temperature:	-40°C - + 95°C	-40°C - + 95°C	-40°C - + 95°C	-40°C - + 95°C
Thread types:	ISO 228, NPT	ISO 228	ISO 228, NPT	ISO 228
Claw distance:	42 mm	42 mm	42 mm	42 mm
Others:	also available in stainless steel	-	also available in stainless steel, also available with colour coated claw	-
Page:	211	213	214	216



With Bore for Safety-Clips	Left-Closing	Made of Hardened Steel	Made of Forged Brass	US-Version with Bore for Safety Clips	US-Version with Bore for Safety Clips - MODY
-----------------------------------	---------------------	-------------------------------	-----------------------------	--	---



Malleable iron (zinc-plated + yellow passivated)	Malleable iron (zinc-plated + yellow passivated)	Steel (hardened, zinc-plated + yellow passivated)	MS 58 plain	Malleable iron (zinc-plated + yellow passivated)	Malleable iron (zinc-plated + yellow passivated)
Malleable iron (zinc-plated + yellow passivated)	Steel (zinc-plated + yellow passivated)	Steel (hardened, zinc-plated + yellow passivated)	MS 58 plain	Malleable iron (zinc-plated + yellow passivated)	Steel (zinc-plated + yellow passivated)
-	MS 58 plain	MS 58 plain	-	-	MS 58 plain
-	-	-	-	-	-
NBR	NBR/ Brass	NBR	NBR	NBR	NBR
TFEP, FKM, EPDM	TFEP, FKM, EPDM	TFEP, FKM, EPDM	-	-	TFEP, FKM, EPDM
PN 10 bar	PN 16 bar	PN 16 bar	PN 10 bar	PN 10 bar	PN 16 bar
-40°C - + 95°C	-40°C - + 95°C	-40°C - + 95°C	-40°C - + 95°C	-40°C - + 95°C	-40°C - + 95°C
ISO 228, NPT	ISO 228	ISO 228, NPT	ISO 228	ISO 228, NPT	ISO 228, NPT
42 mm	42 mm	42 mm	42 mm	41 mm	41 mm
available incl. safety clips (Steel zinc-plated)	also available with colour coated claw	-	French system (according to Norm NF E 29-573)	US-version, available incl. safety clips (Steel zinc-plated)	US-version, available incl. safety clips (Steel zinc-plated)
217	218	219	220	221	222

Standards for Claw Couplings

Claw Couplings according to DIN 3238

New seal holder embedded in coupling body

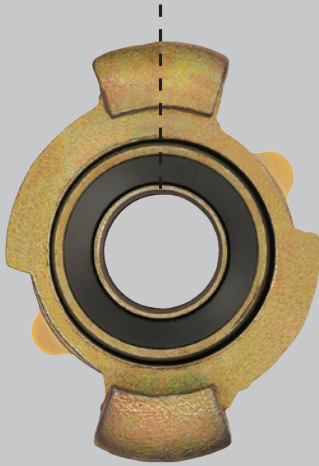

Special requirements

- Threads according to **DIN EN ISO 228-1** and **ANSI/ ASME B 1.20.1**
- Claw couplings and sealing rings corresponding to this standard **must have manufacturer markings!**
- Working pressure **max. 16 bar**
- **100 % sight control**
- **100 % function check with gauge (coupling control)**
- **Approved raw materials used only:**
 - Malleable iron: EN-GJMW-400-5(EN-JM1030) acc. to DIN EN 1562
 - M1-Alloy: Alloy DIN 17660-CuZn39Pb2 (2.0380)
 - Steel: Type to be chosen by manufacturers
 - 11SMnPb30 (1.0718) acc. to DIN EN 10087
 - 11SMnPb30 (1.0718) acc. to DIN EN 10277-3
 - X5CrNi Mo 17-12-2 (1.4401) acc. to DIN EN 10088-1
 - G-X5CrNiMo 19-11-2 (1.4408) acc. to DIN EN 10213-4
 - G-X5CrNiMoNb 19-11-12 (1.4581) acc. to DIN EN 10213-4
- **New seal**
- **New seal holder - 2-way guidance**

Claw Couplings according to DIN 3489

Test gauge for claw couplings

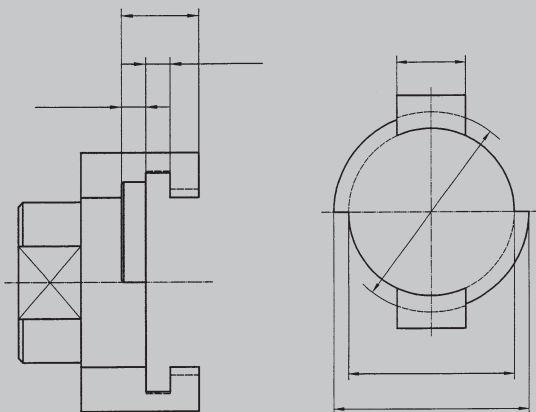

Special requirements

- Threads according to **DIN EN ISO 228-1** and **ANSI/ ASME B 1.20.1**
- Claw couplings and sealing rings corresponding to this standard **must have manufacturer markings!**
- Working pressure **max. 10 bar**
- **100 % sight control required**
- **100 % function check with gauge (coupling control)**
- **Approved raw materials used only:**
 - Malleable iron: EN-GJMW-400-5(EN-JM1030) acc. to DIN EN 1562
 - M1- Alloy: Alloy DIN 17660-CuZn39Pb2 (2.0380)
 - Steel: Type to be chosen by manufacturer
 - 11SMnPb30 (1.0718) acc. to DIN EN 10087
 - 11SMnPb30 (1.0718) acc. to DIN EN 10277-3
 - X5CrNi Mo 17-12-2 (1.4401) acc. to DIN EN 10088-1
 - G-X5CrNiMo 19-11-2 (1.4408) acc. to DIN EN 10213-4
 - G-X5CrNiMoNb 19-11-12 (1.4581) acc. to DIN EN 10213-4

Claw Couplings

Standard Version DIN 3489

- Robust claw couplings made of malleable iron zinc-plated and yellow passivated (free of chrome VI), with safety notches
- 100 % function check and sight control
- With oil-resistant rubber ring GOER, on request with steam resistant rubber ring GDOR made of TFEP (up to +200°C), surcharge: 6.72 Euro
- Universal coupling, worldwide used system for compressed air supply in construction and industry

Materials

- Claw, connector: Malleable iron zinc-plated and yellow passivated (free of chrome VI)
- Seals: NBR

Max. Working Pressure	Temperature	Thread	Norm	Claw distance	Media	
PN 10 bar	-40°C – +95°C	ISO 228, NPT	DIN 3489	42 mm	Compressed Air	10

Also in Stainless steel
Page 330

Claw Couplings with hose barb (formerly DIN 3483)

Hose connection	L	B	L1	Passage	Weight	Type No.
Hose i.D. 6	70	63	25	5	157	SKG 6
Hose i.D. 10	76	63	45	7	150	SKG 10
Hose i.D. 13	69	63	45	8.5	141	SKG 13
Hose i.D. 15	69	63	45	11	142	SKG 15
Hose i.D. 19	69	63	45	15	155	SKG 19
Hose i.D. 25	70	63	46	19	176	SKG 25
Hose i.D. 32	90	63	64	20	244	SKG 32

For hose clamps DIN 20039 A, type SL (© page 253) or crimping ferrules type LPH (© page 401)

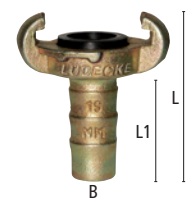

Claw Couplings with hose barb and safety collar

Hose connection	L	B	L1	∅Collar	Passage	Weight	Type No.
Hose i.D. 13	75	63	35.5	25	8.5	174	SKB 13
Hose i.D. 15	75	63	35.5	26	11	175	SKB 15
Hose i.D. 19	75	63	40.5	28.5	15	182	SKB 19
Hose i.D. 19	73.5	63	41	24	15	160	SKB 19 FL*
Hose i.D. 25	75	63	40.5	40	20	240	SKB 25
Hose i.D. 25	75	63	40.5	30	20	190	SKB 25 FL*

For hose clamps DIN 20039 B, type SK (© page 253), safe hose assembly.

*Flat hose version, assembly with hose clamps SK..FL

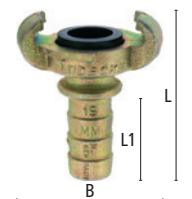

Claw Couplings with female thread (formerly DIN 3482)

Thread connection	L	SW	B	L1	Passage	Weight	Type No.
G 1/4 f	36	22	63	12	11	138	KIG 14
G 3/8 f	36	22	63	12	15	135	KIG 38
G 1/2 f	38	27	63	12	19	150	KIG 12
G 1/2 f	41	-	63	14.5	19	180	KIGO 12**
G 3/4 f	40	32	63	14.5	20	155	KIG 34
NPT 3/4 f	38	32	63	17	20	160	KIG 34 NPT
G 3/4 f	41	-	63	14.5	20	155	KIGO 34**
G 1 f	40	41	63	18	20	184	KIG 10
NPT 1 f	40	40	63	18	20	180	KIG 10 NPT
G 1 1/4 f	55	50	63	18	20	297	KIG 54

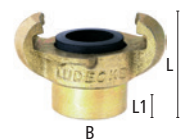
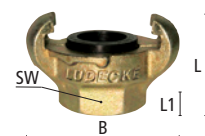

Claw Couplings with blank ends (formerly DIN 3484)

Version	L	B		Weight	Type No.
without chain	43	63	10	130	VKO
with chain	43	63	10	140	VKM
chain, spare part (steel zinc-plated)	200	-	25	7	VKM-K



Claw Couplings

Standard Version DIN 3489

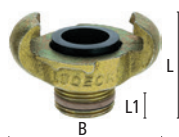
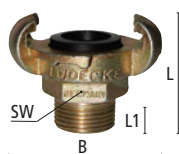

Claw Couplings with male thread (formerly DIN 3481)

Thread connection	L	SW	B	L1	Passage	Weight	Type No.
G 1/4 m	50	22	63	9	6	157	KAG 14
G 3/8 m	52	27	63	14	9	170	KAG 38
G 1/2 m	47	27	63	14	13	162	KAG 12
NPT 1/2 m	49	27	63	16	13	166	KAG 12 NPT
G 3/4 m	50	32	63	14,5	17	175	KAG 34
NPT 3/4 m	49	32	63	17	18	176	KAG 34 NPT
G 3/4 m	41	-	63	15	17	150	KAGO 34**
G 1 m	47	40	63	15	20	174	KAG 10
NPT 1 m	48	40	63	15	20	196	KAG 10 NPT
G 1 m	41	-	63	15	20	165	KAGO 10**
G 1 1/4 m	52	46	63	18	20	230	KAG 54

Male thread sealing with PVC sealing ring type HPD (☉ below)

**without Hexagon, with LÜDSY-sealing ring

Max. Working Pressure	Temperature	Thread	Claw distance	Media
PN 10 bar	-40°C – +95°C	ISO 228/ DIN EN 10226	42 mm	Air

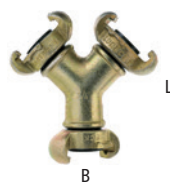

Three-way connections with thread connection or claw couplings (rubber seal)

Connection	L	B	Material	Seal	Passage	☉	Weight	Type No.
3 x R 3/4 f	68	68	Malleable iron	-	24	1	255	DWS 34
3 x KAGO 34	120	120	Malleable iron	NBR	17	1	708	DWSG 34
3 x R 1 f	85	85	Malleable iron	-	30	1	413	DWS 10
3 x KAGO 10	135	130	Malleable iron	NBR	21	1	905	DWSG 10

Original Rubber Rings for Standard Claw Couplings DIN 3489

Resistance	L	D	D1	Material	Temp °C	Media	Colour	Shore A	☉	Weight	Type No.
Oil	11	34	20	NBR	-40 – +95	Compr. Air	black	65°	100	6	GOER
Steam	10	33	20	TFEP	-15 – +200	Steam	red	65°	10	6	GDOR
Chemicals	10.5	34	20	FKM	-40 – +200	Chemical	green	50°	10	9	GVOR

Hard PVC Sealing Rings for fast, easy and tight sealing of male threads

For male thread	L	D	D1	☉	Weight	Type No.
G 1/8 m	1.5	13	10	100	0.13	HPD 18
G 1/4 m	2	17.5	13.5	100	0.31	HPD 14
G 3/8 m	2	20.8	16.9	100	0.37	HPD 38
G 1/2 m	2	25.5	21.2	100	0.53	HPD 12
G 3/4 m	2	31.5	26.4	100	0.73	HPD 34
G 1 m	2	40	33.5	100	1.15	HPD 10

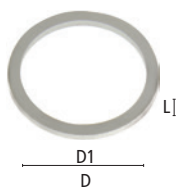

Claw Couplings

Swivelling, DIN 3489

- High-quality claw couplings, head made of malleable iron, thread connections and hose stem made of turned steel with special profile, zinc-plated and yellow passivated (free of chrome VI) with safety notches
- Easy 360° turning under pressure, therefore no hose twist
- Sealed by two O-rings, mounted on 2 teflon washers, safe and protected
- 100 % leakage-proof through machined seal holder, standard sealing can be used (GOER)
- Maximum bore for maximum flow rate
- On request with steam resistant sealing GDOR made of TFEP (surcharge: 6.72 euros)
- 100 % function check and sight control
- For flexible compressed air supply in construction and industry, if used as thread coupling assembled at the tool up to 10 times higher durability compared to rigid standard couplings! The swivel principle absorbs all vibrations!



Materials

- Claw: Malleable iron zinc-plated and yellow passivated (free of chrome VI)
- Connector: Steel zinc-plated and yellow passivated (free of chrome VI)
- Seals: NBR

Max. Working Pressure	Temperature	Thread	Norm	Claw distance	Media	⊠
PN 16 bar	-40°C – +95°C	ISO 228	DIN 3489	42 mm	Air a.o.	5

Claw Couplings with hose barb

Hose connection	L	B	L1	Passage	Weight	Type No.
Hose i.D. 13	87	63	41	10	221	SKG 13-DR
Hose i.D. 19	87	63	41	15	230	SKG 19-DR
Hose i.D. 25	87	63	41	19	260	SKG 25-DR

For hose clamps DIN 20039 A type SL (⊗ page 253) or crimping ferrules type LPH (⊗ page 401)

Claw Couplings with hose barb and safety collar

Hose connection	L	B	L1	∅Collar	Passage	Weight	Type No.
Hose i.D. 13	96	63	41	24	10	236	SKB 13-DR
Hose i.D. 19	98	63	41	34	15	250	SKB 19-DR
Hose i.D. 25	98	63	41	39	19	290	SKB 25-DR

For hose clamps DIN 20039 B type SK (⊗ page 413)

Claw Couplings with female thread

Thread connection	L	B	SW	L1	Passage	Weight	Type No.
G 1/2 f	61	63	24	15	17	240	KIG 12-DR
G 3/4 f	85	63	32	15	17	330	KIG 34-DR
G 1 f	90	63	41	15	17	430	KIG 10-DR

Claw Couplings with male thread

Thread connection	L	B	SW	L1	Passage	Weight	Type No.
G 1/2 m	67	63	24	14	13	240	KAG 12-DR
G 3/4 m	68	63	24	15	17	236	KAG 34-DR
G 1 m	83	63	36	15	19	315	KAG 10-DR

Original Rubber Rings

Resistance	L	D	D1	Material	Temp.°C	Media	Colour	Shore A	⊠	Weight	Type No.
Oil	11	34	20	NBR	-40 – +95	Compr. Air	black	65°	100	6	GOER
Steam	10	33	20	TFEP	-40 – +200	Steam	red	65°	10	6	GDOR

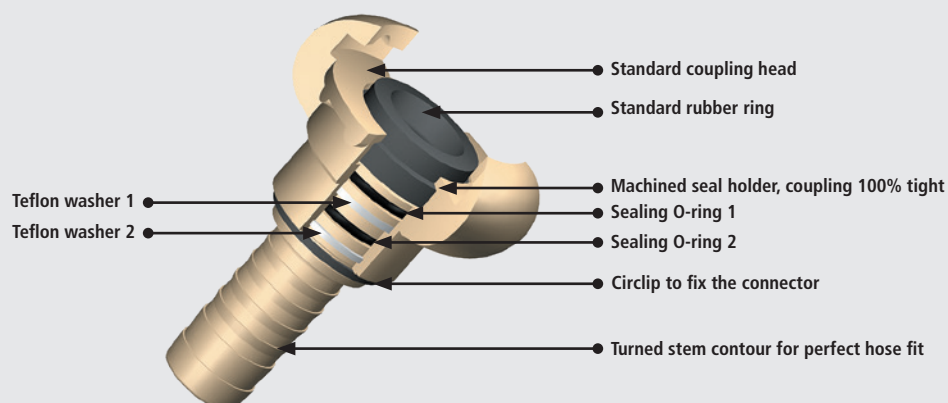
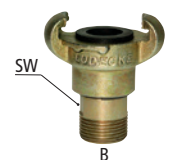
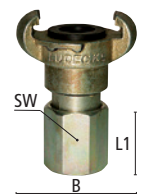
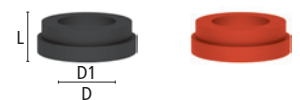

Claw Couplings

MODY-Safety-Screwing Couplings DIN 3238

100 %
 - Easy handling
 - Safe
 - Leakage-proof

- High-quality safety-screwing couplings, claw made of malleable iron with safety notches, hose stem made of turned steel with special contour, zinc-plated and yellow passivated (free of chrome VI)
- Reinforced thread protection ring and new sealing ring, holder embedded in coupling body
- With oil resistant rubber ring, on request with steam resistant rubber ring made of TFEP (up to +200°C)
- 100 % leakage-proof, reduces expensive air consumption • 100 % function check and sight control
- Easy to couple, secured against accidental opening through tightening the locking nut
- Maximum bore for maximum flow rate
- For absolutely safe compressed air supply in construction and industry

Materials

- Claw: Malleable iron zinc-plated and yellow passivated (free of chrome VI)
- Locking nut, safety clamps: Brass MS 58 plain
- Connector: Steel zinc-plated and yellow passivated (free of chrome VI) • Seals: NBR

Also in Stainless steel
 Page 331

Max. Working Pressure	Temperature	Thread	Norm	Claw distance	Media	
PN 16 bar	-40°C – +95°C	ISO 228	DIN 3238, NPT	42 mm	Compressed Air	5



MODY-Safety-Screwing Couplings with hose barb

Hose connection	L	B	L1	Passage	Weight	Type No.
Hose i.D. 10	100	63	41	6.5	309	SSG 10
Hose i.D. 13	100	63	41	10	309	SSG 13
Hose i.D. 15	100	63	41	11	316	SSG 15
Hose i.D. 19	100	63	41	15	319	SSG 19
Hose i.D. 25	100	63	41	18	346	SSG 25
Hose i.D. 32	135	63	48	18	464	SSG 32

For hose clamps DIN 20039 A type SL (☺ page 253) or crimping ferrules type LPH (☺ page 401)

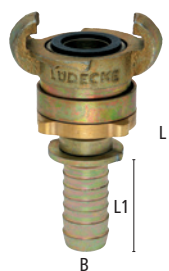

MODY-Safety-Screwing Couplings with hose barb and safety collar

Hose connection	L	B	L1	∅Collar	Passage	Weight	Type No.
Hose i.D. 10	103	63	41	21	6.5	323	SSG 10 S
Hose i.D. 13	110	63	41	24	10	321	SSG 13 S
Hose i.D. 15	112	63	41	27	11	343	SSG 15 S
Hose i.D. 19	112	63	40.5	32	15	350	SSG 19 S
Hose i.D. 25	112	63	40.5	39	18	386	SSG 25 S

For hose clamps DIN 20039 B type SK (☺ page 413)



MODY-Safety-Screwing Couplings with hose barb for crimping ferrules (hydraulic crimping)

Hose connection	L	B	L1	∅Collar	Passage	Weight	Type No.
Hose i.D. 19	108	63	40	24	15	359	SSG 19 PH

Crimping with crimping ferrule PH-19 (☺ page 245)

Other sizes on request



MODY-Safety-Screwing Couplings with hose barb for safety clamps

Hose connection	L	B	L1	∅Collar	Passage	Weight	Type No.
Hose i.D. 19	110	63	35	26	15	340	SSG 19-KSA

For safety clamps VG 85 328 Type KSA 30-33 (☺ page 344)

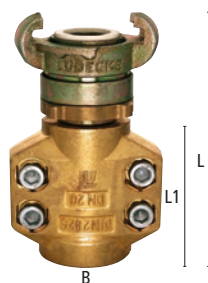

MODY-Safety-Screwing Couplings with brass safety clamp for steam applications

Hose connection	L	B	L1	Passage	Seal	Weight	Type No.
Hose 19x7	113	63	52	15	TFEP (SDOR-N)	920	SSG 19 KSM
Hose 25x7.5	113	63	52	18	TFEP (SDOR-N)	1120	SSG 25 KSM

Claw Couplings

MODY-Safety-Screwing Couplings DIN 3238

Thread ferrule according to DIN EN 14 424 as perfect hose connection for optimum safety; can be unlocked and reused at any time

Please pay attention to details for essential hose wall thickness!

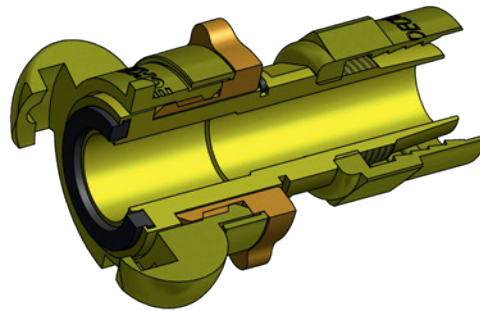

MODY-Safety-Screwing Couplings with thread ferrule (according to DIN EN 14 424)

Hose connection	L	SW	B	SW1	Passage	Weight	Type No.
Hose 13x3	92	27	63	24	11	400	SSG 133 TQ
Hose 13x5	92	27	63	24	11	405	SSG 135 TQ
Hose 15x5	95	32	63	24	13	415	SSG 155 TQ
Hose 19x5	95	32	63	24	16	435	SSG 195 TQ
Hose 19x6	95	36	63	24	16	440	SSG 196 TQ
Hose 25x5	105	41	63	24	22	510	SSG 255 TQ
Hose 25x7	105	46	63	24	22	520	SSG 257 TQ

(Size 1" two parts screwed together)

Assembly instructions for thread ferrules (www.luedecke.com)

MODY-Safety-Screwing Couplings with female thread

Thread connection	L	SW	B	L1	Passage	Weight	Type No.
G 3/8 f	68	24	63	13	13	347	SSGI 38
G 1/2 f	70	24	63	15	17	329	SSGI 12
G 3/4 f	93	32	63	20	17	419	SSGI 34
NPT 3/4 f	93	32	63	21.5	17	388	SSGI 34 NPT
G 1 f	95	41	63	22	17	516	SSGI 10
NPT 1 f	97	41	63	22	17	473	SSGI 10 NPT

MODY-Safety-Screwing Couplings with male thread and LÜDSY-sealing system

Thread connection	L	SW	B	L1	Passage	Weight	Type No.
G 3/8 m	72	24	63	13	10	320	SSGA 38
G 1/2 m	73	24	63	14	13	351	SSGA 12
G 3/4 m	73	24	63	15	17	345	SSGA 34
NPT 3/4 m	73	24	63	18	17	345	SSGA 34 NPT*
R 1 m	85	36	63	18	17	401	SSGA 10
NPT 1 m	83	36	63	19	17	401	SSGA 10 NPT*

*without LÜDSY-thread sealing

Original MODY-Rubber Rings – Standard Version

Resist.	L	D	D1	Material	Temp.°C	Media	Colour	Shore A	Weight	Type No.	
Oil	4	30	21	NBR	-40 – +95	Compr. Air	black	75°	50	1.7	SGOR-N
Steam	4	30	21	TFEP	-15 – +200	Steam	red	65°	10	1.7	SDOR-N

Original MODY-Rubber Rings – Old Version (Only suitable for MODY-Couplings with old seal holder!)

Resist.	L	D	D1	Material	Temp.°C	Media	Colour	Shore A	Weight	Type No.	
Oil	7	33	21	NBR	-40 – +95	Compr. Air	black	60°	50	4	SGOR

All types also available coloured (powder-coated)! Surcharge 3.96 Euro/ piece



RAL 5010



RAL 6029



RAL 1004



RAL 2002

Ⓢ Minimum quantity per type: 100 piece!

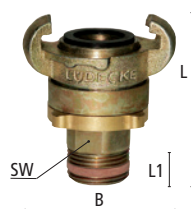
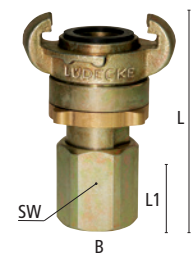
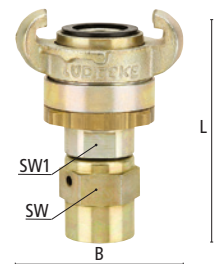

Claw Couplings

with Brass Seal

- Robust claw couplings made of malleable iron zinc-plated and yellow passivated (free of chrome VI) with safety notches
- 100 % function check and sight control
- With brass seal, oil-resistant hose ring and zinc-plated screw
- Easy to couple, no loosening or sticking of the seal by itself when coupled
- Always needs to be coupled with a standard claw coupling with rubber seal!
- **Universal couplings for compressed air supply in construction and industry, mainly used at the compressor or air tool**

Materials

- Claw, connector: Malleable iron zinc-plated and yellow passivated (free of chrome VI)
- Screw: Steel zinc-plated and yellow passivated (free of chrome VI) • Seals: Brass

Max. Working Pressure	Temperature	Thread	Claw distance	Media	
PN 10 bar	-40°C – +95°C	ISO 228	42 mm	Compressed Air	10



Claw Couplings with hose barb and brass seal

Hose connection	L	B	L1	Passage	Weight	Type No.
Hose i.D. 13	78	63	39	8.5	212	SKM 13*
Hose i.D. 15	88	63	39	11	226	SKM 15*
Hose i.D. 19	84	63	46	15	211	SKM 19
Hose i.D. 25	84	63	46	19	225	SKM 25

For hose clamps type SL DIN 20039 A (© page 253)

*two parts with thread stem made of steel

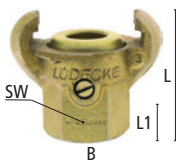

Claw Couplings with female thread and brass seal

Thread connection	L	SW	B	L1	Passage	Weight	Type No.
G 1/2 f	50	32	63	14	17	220	KIM 12
G 3/4 f	50	32	63	14.5	17	200	KIM 34
G 1 f	52	41	63	17	17	260	KIM 10



Claw Couplings with male thread and brass seal

Thread connection	L	SW	B	L1	Passage	Weight	Type No.
G 1/2 m	55	27	63	14	11	193	KAM 12
G 3/4 m	51	32	63	14	17	206	KAM 34
G 1 m	48	40	63	15	17	213	KAM 10

Male thread sealing with PVC sealing ring type HPD (© page 212)

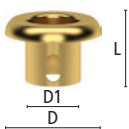

Original spare parts for claw couplings with brass seal

Type	L	D	D1	Material		Weight	Type No.
Brass sleeve	21	32	17	Brass	10	12.5	MOOH
Hose ring	12	28	23	NBR	100	3.2	SOOR
Steel screw M5	14	7	-	Steel zinc-pl. + yellow pass.	100	2	HOOS

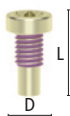

Claw Couplings

with Bore for Safety-Clips

- Robust claw couplings made of malleable iron zinc-plated and yellow passivated (free of chrome VI)
- 100 % function check and sight control
- With oil-resistant rubber ring GOER, on request with steam resistant rubber ring GDOR (up to +200°C), surcharge: 6.72 Euro
- When coupled, can be secured against accidental opening through safety-clips DIN 11024
- Universal coupling, used worldwide mainly in mining or tunnelling

Materials

- Claw, connector: Malleable iron zinc-plated and yellow passivated (free of chrome VI)
- Seals: NBR

Max. Working Pressure	Temperature	Thread	Claw distance	Media	☒
PN 10 bar	-40°C – +95°C	ISO 228, NPT	42 mm	Compressed Air	10

Claw Couplings with hose barb and safety collar

Hose connection	L	B	L1	Passage	Weight	Type No.
Hose i.D. 13	74	63	40	8.5	167	SKSS 13
Hose i.D. 19	75	63	40	15	196	SKSS 19
Hose i.D. 25	75	63	40	19	222	SKSS 25

For hose clamps DIN 20039 B, type SK (☒ page 253) safe hose assembly

Claw Couplings with female thread

Thread connection	L	SW	B	L1	Passage	Weight	Type No.
G 1/2 f	37	27	63	14	18.5	141	KISS 12
G 3/4 f	39	32	63	14.5	20	145	KISS 34
G 1 f	41	41	63	18	20	182	KISS 10
NPT 1 f	41	41	63	18	20	180	KISS 10 NPT

Claw Couplings with male thread

Thread connection	L	SW	B	L1	Passage	Weight	Type No.
G 1/2 m	49	27	63	14	13	170	KASS 12
G 3/4 m	49	32	63	15	17	182	KASS 34
G 1 m	53	39	63	15.5	20	199	KASS 10

Male thread sealing with PVC sealing ring type HPD (☒ page 212)

Original Rubber Rings

Resistance	L	D	D1	Material	Temp.°C	Media	Colour	Shore A	☒	Weight	Type No.
Oil	11	34	20	NBR	-40 – +95	Compr. Air	black	65°	100	6	GOER
Steam	10	33	20	TFEP	-15 – +200	Steam	red	65°	10	6	GDOR

Universal Safety-Clips DIN 11024

L	B	D	Material	☒	Weight	Type No.
63	27	3	Steel zinc-plated	50	10	USC-1

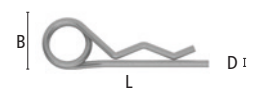
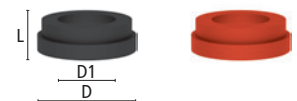
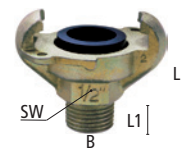
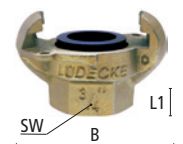
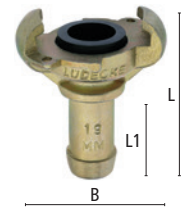

Claw Couplings

Left-Closing and Coloured

100 %

- Easy handling
- Safe
- Leakage-proof

- Robust claw couplings made of malleable iron/ steel zinc-plated and yellow passivated (free of chrome VI) with safety notches and locking nut on female claw couplings left-closing
- 100 % function check and sight control
- With oil-resistant rubber ring SGOR-N, on request with steam resistant rubber ring SDOR-N (up to +200°C), with brass seal and standard seal
- Due to left-closing mechanism, the couplings cannot be connected with standard claw couplings (right-closing), additional warning through flaps at the claws or colour coding
- **Mainly used in chemical and petrochemical industry to make false coupling impossible when using different media, e.g. compressed air, steam, gas, nitrogen**

Materials

- Claw: Malleable iron zinc-plated and yellow passivated (free of chrome VI)
- Connector: Steel zinc-plated and yellow passivated (free of chrome VI)
- Locking nut: Brass MS 58 plain
- Seals: NBR/ Brass

Max. Working Pressure	Temperature	Thread	Claw distance	Media	
PN 16 bar	-40°C – +95°C	ISO 228	42 mm	various	1

Claw Couplings left-closing with hose barb

Hose connection	L	B	L1	Passage	Typ	Version	Seal	Weight	Type No.
Hose i.D. 19	100	85	41	16	MODY	w/o safety collar	NBR	340	SSGL 19
Hose i.D. 19	112	85	40.5	16	MODY	w safety collar	NBR	367	SSGL 19 S
Hose i.D. 19	84	85	49	16	MS-Seal	w/o safety collar	Brass	240	SKML 19

Other sizes on request.

For hose clamps DIN 20039 A or B (☺ page 253)

Claw Couplings left-closing with female thread

Thread connection	L	SW	B	L1	Passage	Typ	Seal	Weight	Type No.
G 3/4 f	38	40	85	16	20	Standard	NBR	210	KIGL 34
G 3/4 f	93	32	85	20	19	MODY	NBR	434	SSGIL 34
G 1 f	39	40	85	18	20	Standard	NBR	180	KIGL 10

Other sizes on request.

Couplings left-closing with male thread

Thread connection	L	SW	B	L1	Passage	Typ	Seal	Weight	Type No.
G 3/4 m	73	24	85	15	19	MODY	NBR	339	SSGAL 34

Other sizes on request.

Original Standard-Rubber Rings

(☺ page 212)

Original MODY-Rubber Rings - Standard Version

(☺ page 215)

Original MODY-Rubber Rings - Old Version

(☺ page 215)

Original Spare Parts for Claw Couplings with Brass Seal

Type	L	D	D1	Material		Weight	Type No.
Brass sleeve	21	32	17	Brass	10	12.5	MOOH
Hose ring	12	28	23	NBR	100	3.2	SOOR
Steel screw M5	14	7	-	Steel zinc-pl. + yellow pass.	100	2	HOOS

All types also available coloured (powder-coated)! Surcharge 3.96 Euro/ piece

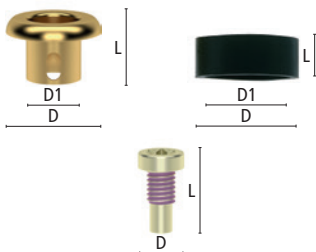
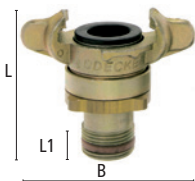
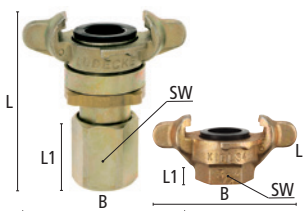
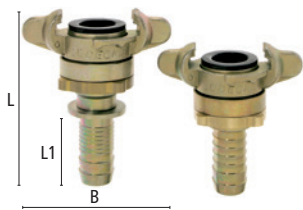

RAL 5010



RAL 6029



RAL 1004



RAL 2002

...others on request.

Ⓜ Minimum quantity per type: 100 pieces!

Claw Couplings

made of Hardened Steel, Interchangeable with Type „Atlas Copco“

- Durable, extremely robust claw coupling made of steel, additionally hardened, zinc-plated and yellow passivated (free of chrome VI), equivalent to type Atlas Copco
- With oil-resistant rubber ring GOER, on request with steam resistant rubber ring GDOR (up to +200°C), surcharge: 6,72 Euro
- Maximum bore for maximum flow rate to reach best tool performance
- Turned stem profile for perfect hose fit - Turned gasket seat, therefore 100 % leakage-proof
- High-quality coupling for compressed air supply in construction and industry

Materials

- Claw, connector: Steel hardened, zinc-plated and yellow passivated (free of chrome VI)
- Locking nut: Brass MS 58 plain
- Seals: NBR

Max. Working Pressure	Temperature	Thread	Claw distance	Media	
PN 16 bar	-40°C – +95°C	ISO 228, NPT	42 mm	Compressed Air	10

Claw Couplings with hose barb

Hose connection	L	B	L1	Passage	Weight	Type No.
Hose i.D. 10	63	62	35	8	141	ACK 38 T
Hose i.D. 12.5	63	62	35	10.5	136	ACK 12 T
Hose i.D. 20	70	62	45	17	165	ACK 34 T
Hose i.D. 25	73	62	46	20	173	ACK 10 T

For hose clamps DIN 20039 A, type SL (☺ page 253)

Swivelling version on request.



Claw Couplings with female thread

Thread connection	L	B	L1	Passage	Weight	Type No.
G 3/8 f	40	62	16	15	182	ACK 38 I
G 1/2 f	40	62	16	19	203	ACK 12 I
G 3/4 f	40	62	16	20	176	ACK 34 I
NPT 3/4 f	40	62	16	20	176	ACK 34 I-NPT
G 1 f	40	62	17	20	160	ACK 10 I
NPT 1 f	40	62	17	20	155	ACK 10 I-NPT

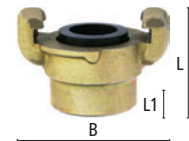

Claw Couplings with male thread

Thread connection	L	B	L1	Passage	Weight	Type No.
G 3/8 m	40	62	14	11	142	ACK 38 A
G 1/2 m	40	62	14	15	152	ACK 12 A
G 3/4 m	40	62	15	19	148	ACK 34 A
NPT 3/4 m	41	62	16	19	150	ACK 34 A-NPT
G 1 m	40	62	15	20	152	ACK 10 A

Male thread sealing with PVC sealing ring type HPD and original rubber rings (☺ page 212)

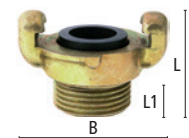

Blank Ends

Version	L	B		Weight	Type No.
without chain	40	62	10	140	ACKO
with chain	40	62	10	150	ACKM
chain (spare part)	200	-	25	7	VKM-K

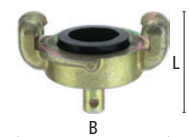

MODY-Safety-Screwing Couplings with hose barb and thread-protective ring and new sealing-ring, on both sides guided in seal holder

Hose connection	L	B	L1	Passage		Weight	Type No.
Hose i.D. 12.5	92	62	41	10	5	321	ACS 13
Hose i.D. 19	92	62	41	17	5	331	ACS 19
Hose i.D. 25	92	62	41	19	5	356	ACS 25

For hose clamps DIN 20039 A, type SL (☺ page 253)

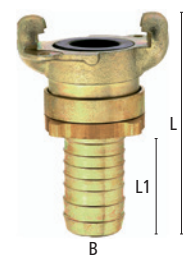

Original MODY-Rubber Rings – Standard and Old Version

(☺ page 215)

Claw Couplings

made of Forged Brass MS 58

- "French System" with a claw distance of 42 mm
- Universal couplings made of brass MS 58
- With oil-resistant rubber ring MK 42 ER
- Turned gasket seat, therefore 100 % leakage-proof
- According to NF E 29-573
- For compressed air and water supply in construction, agriculture and industry

Materials

- Claw, connector: Brass MS 58 plain
- Seals: NBR

Max. Working Pressure	Temperature	Thread	Claw distance	Media	
PN 10 bar	-40°C – +95°C	ISO 228	42 mm	Compressed Air, Water	10

Claw Couplings with hose barb

Hose connection	L	B	L1	Passage	Weight	Type No.
Hose i.D. 6	76	57	39.5	6	115	MKS 42-6
Hose i.D. 10	69	57	36.5	8	120	MKS 42-10
Hose i.D. 13	69	57	36.5	10	130	MKS 42-13
Hose i.D. 16	69	57	36.5	12	131	MKS 42-15
Hose i.D. 19	69	57	36.5	15	155	MKS 42-19
Hose i.D. 25	69	57	40	21	180	MKS 42-25

For hose clamps/clips type SL, type HS, ZOS, LPH (© page 397 - 401)



Claw Couplings with female thread

Thread connection	L	SW	B	L1	Passage	Weight	Type No.
G 1/4 f	38	17	57	13.5	8	93	MKI 42-14
G 3/8 f	33	21	57	10.5	12	97	MKI 42-38
G 1/2 f	33	26	57	11.5	15	101	MKI 42-12
G 3/4 f	36	32	57	14	21	119	MKI 42-34
G 1 f	38	39	57	15	21	124	MKI 42-10
G 1 1/4 f	43	47	57	15	21	166	MKI 42-54

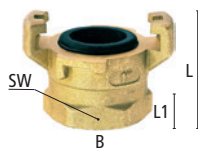

Claw Couplings with male thread

Thread connection	L	SW	B	L1	Passage	Weight	Type No.
G 1/4 m	43	17	57	10.5	7	104	MKA 42-14
G 3/8 m	45	21	57	11	10	102	MKA 42-38
G 1/2 m	42	24	57	10	14	112	MKA 42-12
G 3/4 m	43	30	57	11	19	135	MKA 42-34
G 1 m	43	34	57	11	21	140	MKA 42-10
G 1 1/4 m	46	44	57	13	21	193	MKA 42-54

Male thread sealing with PVC sealing ring type HPD (© page 212)

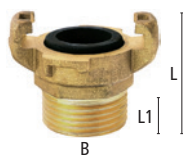

Claw Couplings with blank ends

Version	L	B	Weight	Type No.
without chain	29	57	93	MKO 42

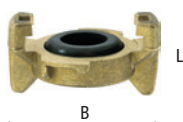

Original Rubber Ring

Resistance	L	D	D1	Material	Temp.°C	Media	Colour	Shore A	Weight	Type No.	
Oil	10	34.5	21	NBR	-40 – +95	Air/Water	black	55°	10	5	MK 42 ER



Claw Couplings

US-Version with Bore for Safety-Clips

- Robust claw couplings made of malleable iron, US-Version, zinc-plated and yellow passivated (free of chrome VI)
- 100 % function check and sight control
- With oil-resistant rubber ring GOOR
- When coupled, can be secured against accidental opening through safety-clips DIN 11024
- US-universal coupling, common used system for compressed air supply in construction and industry

Materials

- Claw, connector: Malleable iron zinc-plated and yellow passivated (free of chrome VI)
- Seals: NBR

Max. Working Pressure	Temperature	Thread	Claw distance	Media	⊞
PN 10 bar	-40°C – +95°C	ISO 228, NPT	41 mm	Air a.o.	10

US-Claw Couplings with hose barb and safety collar

Hose connection	L	B	L1	Passage	Weight	Type No.
Hose i.D. 10	75	62	32	6	162	SKA 11*
Hose i.D. 13	88	62	42	9	182	SKA 13
Hose i.D. 19	105	62	56	14	244	SKA 19
Hose i.D. 25	107	62	59	20	286	SKA 25

For US-hose clamps (© page 254)

*SKA 11 two parts with thread stem made of steel

US-Claw Couplings with female thread

Thread connection	L	SW	B	L1	Passage	Weight	Type No.
G 3/8 f	57	27	62	13.5	15	180	KIA 38 BSP
NPT 3/8 f	57	27	62	13.5	15	187	KIA 38
G 1/2 f	57	27	62	13.5	18	173	KIA 12 BSP
NPT 1/2 f	57	27	62	13.5	18	181	KIA 12
G 3/4 f	57	36	62	15	20	195	KIA 34 BSP
NPT 3/4 f	57	36	62	15	20	201	KIA 34
G 1 f	57	42	62	15	20	208	KIA 10 BSP
NPT 1 f	57	42	62	15	20	218	KIA 10

US-Claw Couplings with male thread

Thread connection	L	SW	B	L1	Passage	Weight	Type No.
G 3/8 m	56	29	62	14	9	200	KAA 38 BSP
NPT 3/8 m	64	29	62	15	9	180	KAA 38
G 1/2 m	56	29	62	14	12	210	KAA 12 BSP
NPT 1/2 m	64	29	62	20	12	190	KAA 12
G 3/4 m	64	34	62	16	17	225	KAA 34 BSP
NPT 3/4 m	70	34	62	20	17	224	KAA 34
G 1 m	68	38	62	18	20	250	KAA 10 BSP
NPT 1 m	72	38	62	23	20	260	KAA 10

US-Claw Couplings with blank end

Version	L	B	Weight	Type No.
without chain	55	62	215	UDM

Original Rubber Ring

Resistance	L	D	D1	Material	Temp.°C	Media	Colour	Shore A	⊞	Weight	Type No.
Oil	10.5	34	20	NBR	-40 / +95	Compr. Air	black	50 °	100	6	GOOR

Universal Safety Clips DIN 11024

L	B	D	Material	⊞	Weight	Type No.
27	63	3	Steel zinc-plated	50	10	USC-1

Coupling not possible with claw distance of 42 mm

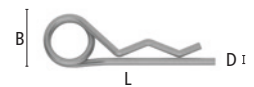
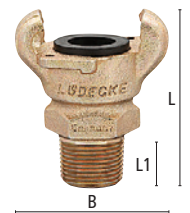
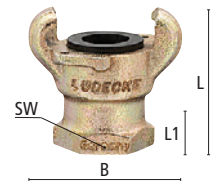

Claw Couplings

US-Version with Bore for Safety-Clips MODY-Safety-Screwing Couplings

100 % - Easy handling
- Safe
- Leakage-proof

- High-quality MODY-safety-screwing couplings, hose stem with special contour
- Reinforced thread protection ring and new sealing ring, holder embedded in coupling body
- With oil resistant rubber ring, on request with steam resistant rubber ring made of TFEP (up to +200°C)
- 100 % leakage-proof, reduces expensive air consumption
- 100 % function check and sight control
- Easy to couple, secured against accidental opening through tightening the locking nut, additional safety with safety-clips DIN 11024
- Maximum bore for maximum flow rate
- For absolutely safe compressed air supply in construction and industry

Materials

- Claw: Malleable iron zinc-plated and yellow passivated (free of chrome VI)
- Connector: Steel zinc-plated and yellow passivated (free of chrome VI)
- Locking nut: Brass MS 58 plain
- Seals: NBR

Coupling not possible with claw distance of 42 mm

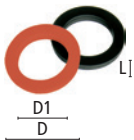
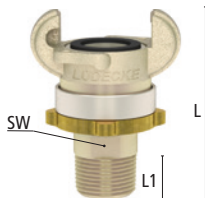
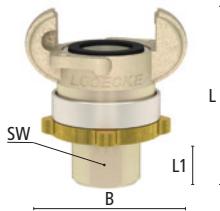
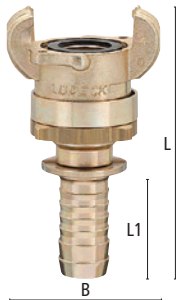

Max. Working Pressure	Temperature	Thread	Claw distance	Media	
PN 16 bar	-40°C – +95°C	ISO 228, NPT	41 mm	Compressed Air	5

US-MODY-Safety-Screwing Couplings with hose barb and safety collar

Hose connection	L	B	L1	ØCollar	Passage	Weight	Type No.
Hose i.D. 10	111	62	41	21	6.5	320	SSC 10
Hose i.D. 13	118	62	41	24	10	360	SSC 13
Hose i.D. 19	120	62	40.5	34	15	385	SSC 19
Hose i.D. 25	120	62	40.5	39	18	420	SSC 25

For US-hose clamps (© page 254)

US-MODY-Safety-Screwing Couplings with female thread

Thread connection	L	SW	B	L1	Passage	Weight	Type No.
G 3/8 f	64	24	62	13	13	250	SSCI 38
NPT 3/8 f	64	24	62	13	13	252	SSCI 38 NPT
G 1/2 f	65	24	62	15	17	280	SSCI 12
NPT 1/2 f	65	24	62	15	17	290	SSCI 12 NPT
G 3/4 f	92	32	62	20	17	420	SSCI 34
NPT 3/4 f	92	32	62	20	17	420	SSCI 34 NPT

US-MODY-Safety-Screwing Couplings with male thread

Thread connection	L	SW	B	L1	Passage	Weight	Type No.
G 3/8 m	72	24	62	13	10	260	SSCA 38*
NPT 3/8 m	72	24	62	13	10	270	SSCA 38 NPT
G 1/2 m	74	24	62	14	13	260	SSCA 12*
NPT 1/2 m	74	24	62	14	13	270	SSCA 12 NPT
G 3/4 m	75	24	62	15	17	270	SSCA 34*
NPT 3/4 m	75	24	62	15	17	280	SSCA 34 NPT

*with LÜDSY- Thread sealing

Original MODY-Rubber Rings – Standard Version

Resistance	L	D	D1	Material	Temp.°C	Media	Colour	Shore A	Weight	Type No.	
Oil	4	30	21	NBR	-40 – +95	Compr. Air	black	75°	50	1.7	SGOR-N
Steam	4	30	21	TFEP	-15 – +200	Steam	red	65°	10	1.7	SDOR-N



Complete Screwing Sets, FlatLock Flat Hose Screwings, Connecting Nipples, Hose Connections



For media supply (especially for compressed air and water) in construction as well as in mining and tunnelling, the **LUDECKE** product portfolio comprises a broad range of different screwings, assembly types and matching accessories.

The screwings and fittings are extremely robust and resistant to dirt or damages. They also offer highest safety and optimum ease of use when assembling various hoses.

The appropriate version is always adjusted to the specific hose and customised.

Advantages:

- High-quality materials
- Robust, reliable, absolutely leakage-proof and durable
- Quick and easy handling
- Different sizes, versions and connection types
- Individual adjustment of the respective execution

Multifunctional Use

The different versions of this product range can be utilized in various areas and are a tidy alternative to conventional classic fittings and assembly methods.



Note: In general, the distributor of a hose line can be held liable for possible recourse claims due to personal injury and/or damage to property as well as production downtime! For this reason, we are happy to help you select the right solution for your application. Various product and safety data sheets are always available free of charge on the **LUDECKE** homepage (→ www.ludecke.com/support).

Complete Screwing Sets



Complete Screwing Sets are extremely robust fittings for construction and mining. They are easy to use: A tapered stem with connecting nut is screwed with a nipple with cone. Taper and cone are sealing against each other without further sealing material. Flat sealed versions can be combined with versions, that have no cone ("Atlas Copco" system).

FlatLock Flat Hose Screwings

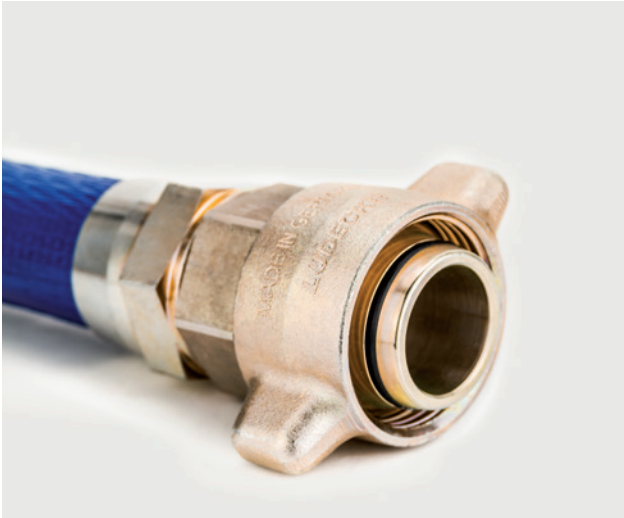

Customers looking for a secure way to assemble flat hoses, will find the right solution with the FlatLock flat hose screwings. These fittings are characterised by easy installation and perfect ergonomics when assembling thin walled flat hoses. They can be loosened and reused at any time.

This extremely safe and reliable hose connection is available for the following coupling systems:

- MODY-Safety-Screwing Couplings DIN 3238
- Female and male thread screwings
- Complete Screwing Sets DIN 20 033

In addition to the standard range, we also manufacture flat hose screwings according to certain specifications or hose samples including assembly recommendations for crimping ferrule, safety clamp, wire or steel band.

Hot Tar Screwings



The **LUDECKE** hot tar screwings are made of steel/ malleable iron zinc-plated and yellow passivated (free of chrome VI) and are used to connect hoses to tar spraying equipment, lances, etc.

They are operated by a wing nut and a tapered stem with a safety collar.

Thread Stems and Hose Connections



Thread stems and hose connections are applied in different areas to connect or extend hose lines.

Overview of Screwings

Complete Screwing Sets

DIN 8537/ 20 033



Flat Hose Screwings

DIN 3238/ 20 033



**Flat
Lock**
by LUDECKE

Hot Tar Screwings



Materials		Materials		Materials	
Tapered stem:	Steel/ Malleable iron (zinc-plated + yellow passivated)	Connecting nut:	Malleable iron (zinc-plated + yellow passivated)	Tapered stem:	Steel (zinc-plated + yellow passivated)
Connecting nut:	Malleable iron (zinc-plated + yellow passivated)	Hose connections, squeeze ring, squeeze nut:	Steel (zinc-plated + yellow passivated)	Wing nut:	Malleable iron (zinc-plated + yellow passivated)
Seals:	NBR	Locking nut:	MS 58 plain	Nipple:	Steel (zinc-plated + yellow passivated)
Max. Working Pressure:	PN 16/ 25 bar*	Seals:	NBR	Max. Working Pressure:	PN 25 bar
Temperature:	-40°C - + 95°C	Max. Working Pressure:	PN 16/ 25 bar*	Temperature:	up to +200°C
Thread types:	ISO 228/ DIN 405	Temperature:	-40°C - + 100°C	Thread types:	ISO 228
Page:	227	Thread types:	ISO 228/ DIN 405	Page:	235
		Page:	232		

*subject to temperature and assembly method

Double Nipples



Connecting Nipples



Thread Stems



Hose Connections



Thread Ferrule Screwings



Materials		Materials		Materials		Materials	
Body:	Steel (zinc-plated + yellow passivated)	Steel/ Malleable iron (zinc-plated + yellow passivated)	Steel (zinc-plated + yellow passivated)	Steel (zinc-plated + yellow passivated)	Steel (zinc-plated + yellow passivated)	Steel (zinc-plated + yellow passivated)	Steel (zinc-plated + yellow passivated)
Max. Working Pressure:	PN 25 bar	PN 25 bar	PN 16/ 25 bar	PN 16/ 25 bar	PN 16/ 25 bar	PN 16/ 25 bar	PN 16/ 25 bar
Thread types:	ISO 228/ DIN 405	ISO 228/ DIN 405	ISO 228/ DIN 405	-	-	ISO 228	ISO 228
Page:	234	234	236	237	237	237	237

Complete Screwing Sets

DIN 8537/20 033 with Hose Stem

- Complete screwing sets made of steel/ malleable iron zinc-plated and yellow passivated (free of chrome VI), consisting of connecting nut and tapered stem
- Complete screwing sets with safety collar and turned stem profile for perfect hose fit
- Tapered stems with cone 1:3 always with additional O-ring sealing
- Suitable for connecting nipples (☺ page 234/ 235)
- Worldwide used system for compressed air supply water, etc. in construction, mining or tunnelling

Materials

- Tapered stem: Steel/ malleable iron zinc-plated and yellow passivated (free of chrome VI)
- Connecting nut: Malleable iron zinc-plated and yellow passivated (free of chrome VI)
- Seals: NBR

Max. Working Pressure	Temperature	Thread	Norm	Media
PN 16 / 25 bar	- 40°C – + 95°C	ISO 228 / DIN 405	DIN 8537 / 20 033	Compressed Air / Water

Complete Screwing Sets with safety collar

Hose connect.	Thread connect.	L	B	Cone	∅Collar	Passage	Weight	Type No.
Hose i.D. 13	G 3/4 f	79	58	1:4	21	10	166	34/13 S
Hose i.D. 15	G 3/4 f	79	58	1:4	26	12	175	34/15 S
Hose i.D. 19	G 3/4 f	80	58	1:4	33	13	200	34/19 S
Hose i.D. 19	G 1 f	85	65	1:3	33	15	244	10/19 S
Hose i.D. 25	G 1 f	90	65	1:3	38	16	290	10/25 S
Hose i.D. 13	Rd 32x1/8 f	83	65	1:3	22	10	249	32/13 S
Hose i.D. 15	Rd 32x1/8 f	85	65	1:3	26	12	229	32/15 S
Hose i.D. 19	Rd 32x1/8 f	85	65	1:3	33	15	251	32/19 S
Hose i.D. 25	Rd 32x1/8 f	90	65	1:3	38	16	310	32/25 S
Hose i.D. 25	Rd 38x1/8 f	98	76	1:3	38	19	426	38/25 S
Hose i.D. 32	Rd 46x1/6 f	124	86	1:3	50	25	685	46/32 S
Hose i.D. 35	Rd 55x1/6 f	131	95	1:3	55	30	829	55/35 S
Hose i.D. 38	Rd 55x1/6 f	131	95	1:3	55	31	864	55/38 S
Hose i.D. 42	Rd 62x1/6 f	139	105	1:3	63	35	1216	62/42 S
Hose i.D. 38	Rd 75x1/6 f	140	137	1:3	55	31	1420	75/38 S
Hose i.D. 50	Rd 75x1/6 f	149	137	1:3	77	45	1725	75/50 S
Hose i.D. 53	Rd 75x1/6 f	149	137	1:3	77	45	1848	75/53 S
Hose i.D. 75	Rd 105x1/4 f	206	158	1:3	110	67	3974	105/75 S

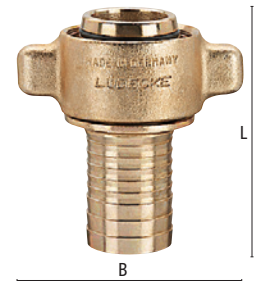

For hose clamps DIN 20039 B, type SK (☺ page 253)

For higher temperatures and pressure we recommend steam screwings DIN EN 14423 (☺ page 340)

FlatLock Flat Hose Screwings (☺ page 232)

We also manufacture flat hose screwings according to certain specifications or hose samples including assembly recommendations for crimping ferrule, safety clamp, wire or steel band. Various types on stock!



NEW!

High pressure applications:

For products that require 40 bar to 100 bar operating pressure, please contact our expert sales team.

Connecting Nuts and Tapered Stems

DIN 8537/20 033

- Screwings with cone made of steel/ malleable iron zinc-plated and yellow passivated (free of chrome VI), consisting of connecting nut and tapered stem without safety collar
- Turned stem profile for perfect hose fit
- Tapered stems with cone 1:3 always with additional O-ring sealing
- Suitable for connecting nipples (☺ page 234/ 235)
- **Worldwide used system for compressed air supply, water, etc. in construction, mining or tunnelling**

Max. Working Pressure	Temperature	Media
PN 16 / 25 bar	- 40°C – + 95°C	Compressed Air / Water

Connecting Nuts made of malleable iron corresponding to →

Thread connection	L	B	Passage		Weight	Type No.
G 3/4 f	23	58	21.5	10	92	UM 34
G 1 f	28	65	23	10	133	UM 10
Rd 32x1/8 f	28	65	23	10	139	UM 32
Rd 32x1/8 f	28	65	27,5	10	129	UM 32/2
G 1 f	28	65	27,5	10	124	UM 10/2
Rd 38x1/8 f	33	76	29	10	234	UM 38 UM 38-L
Rd 46x1/6 f	36	86	35	1	301	UM 46
Rd 55x1/6 f	38	95	43	1	378	UM 55
Rd 62x1/6 f	44	105	49	1	555	UM 62
Rd 75x1/6 f	50	137	61	1	797	UM 75
Rd 105x1/4 f	60	158	89	1	1545	UM 105



Materials

- Connecting nut: Malleable iron zinc-plated and yellow passivated (free of chrome VI)
- Tapered stem: Steel zinc-plated and yellow passivated (free of chrome VI)
- Seals: NBR

Tapered stems made of steel

Hose connection	L	B	Cone		Weight	Type No.
Hose i.D. 13	79	24	1:4	10	74	T 13 B
Hose i.D. 15	79	24	1:4	10	72	T 15 B
Hose i.D. 19	80	24	1:4	10	94	T 19 B
Hose i.D. 13	80	28	1:3	10	104	ST 13 B
Hose i.D. 15	80	28	1:3	10	83	ST 15 B
Hose i.D. 19	80	28	1:3	10	100	ST 19 B
Hose i.D. 19	80	28	1:3	10	105	ST 19 B-PH*
Hose i.D. 13	80	28	1:3	10	104	ST 13 B
Hose i.D. 15	80	28	1:3	10	83	ST 15 B
Hose i.D. 19	80	28	1:3	10	100	ST 19 B
Hose i.D. 19	80	28	1:3	10	109	ST 19 B-PH*
Hose i.D. 25	85	29	1:3	10	163	ST 25 B/3
Hose i.D. 25	85	30	1:3	10	148	ST 25 B/2
Hose i.D. 25	90	33	1:3	10	164	ST 25 B
Hose i.D. 25	88,5	33	1:3	10	200	ST 25 B-PH*
Hose i.D. 32	120	40	1:3	1	355	ST 32 B
Hose i.D. 38	125	48	1:3	1	465	ST 38 B
Hose i.D. 38	110	48	1:3	1	420	ST 38 B-PH*
Hose i.D. 42	130	57	1:3	1	558	ST 42 B
Hose i.D. 50	140	68	1:3	1	896	ST 50 B
Hose i.D. 53	140	68	1:3	1	947	ST 53 B
Hose i.D. 75	189	98	1:3	1	1990	ST 75 B



For hose clamps DIN 20039 A, type SL (© page 253)

*for hydraulic crimping with ferrule (© page 245)

other types also available on request!

Complete Screwing Sets

DIN 20 033 with Male Thread

- Screwings with cone made of steel/ malleable iron zinc-plated and yellow passivated (free of chrome VI), consisting of connecting nut and tapered nipple
- Complete screwing set to connect with thread at machine/ tool
- Tapered nipple with cone 1:3 always with additional O-ring sealing
- **Worldwide used system for compressed air supply in construction, mining and tunnelling**

Materials

- Tapered stem: Steel zinc-plated and yellow passivated (free of chrome VI)
- Connecting nut: Malleable iron zinc-plated and yellow passivated
- Seals: NBR

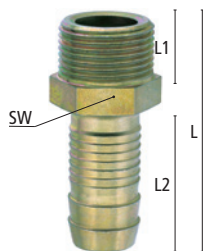
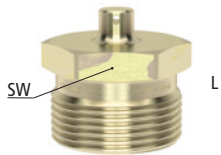
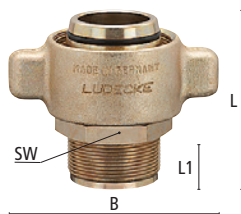

Max. Working Pressure	Temperature	Thread	Norm	Cone	Media	
PN 16 / 25 bar	- 40°C – + 95°C	ISO 228 / DIN 405	DIN 20 033	1:3	Compressed Air	1

Complete Screwing Sets with male thread

Thread connection	L	SW	B	L1	Passage	Weight	Type No.
G 1 1/4 m - RD 55x1/6 f	87	50	95	20	32	890	55/54 A
G 2 m - RD 75x1/6 f	115	65	137	30	45	1850	75/20 A

Other dimensions on request.

Screw Caps for Complete Screwing Sets DIN 20 033

Thread connection	L	SW		Weight	Type No.
Rd 75 x 1/6 f	65	75	5	950	VS 75

With hexagon to facilitate the assembly.

Other dimensions on request.

Male thread stems with cone

Hose connect.	Thread connect.	L	SW	L1	L2	Passage		Weight	Type No.
Hose i.D. 25	Rd 38x1/8 m	75	41	23	41	20	10	210	G 38-25 T
Hose i.D. 38	Rd 55x1/6 m	108	55	32	51	33	1	650	G 55-38 T*
Hose i.D. 50	Rd 75x1/6 m	137	75	40	72	45	1	1400	G 75-50 T*
Hose i.D. 53	Rd 75x1/6 m	137	75	40	72	47	1	1450	G 75-53 T*

*with safety collar

Suitable for Complete Screwing Sets

For hose clamps DIN 20039 A, type SL (☺ page 253)

Other dimensions on request.

Complete Screwing Sets

Flat Sealing, Interchangeable with Type „Atlas Copco“

- Screwings made of steel/ malleable iron zinc-plated and yellow passivated (free of chrome VI)
- Consisting of connecting nut and flat sealing hose stem with O-ring sealing
- Complete screwing sets with turned stem profile for perfect hose fit
- Further assembly methods, for example with crimping ferrules or safety clamps, and other dimensions on request
- Common screwing system for compressed air supply in mining and tunnelling
- Interchangeable with screwing system type "Atlas Copco"

Materials

- Hose stem: Steel zinc-plated and yellow passivated (free of chrome VI)
- Connecting nut: Malleable iron zinc-plated and yellow passivated (free of chrome VI)
- Seals: NBR

Max. Working Pressure	Temperature	Media	Thread	
PN 16 / 25 bar	- 40°C – + 95°C	Compressed Air, Water	DIN 405	1

Complete Screwing Sets flat sealing

Hose connection	Thread connection	L	B	Passage	Weight	Type No.
Hose i.D. 50	Rd 65x1/6 f	166	105	45	1300	65/50 FL
Hose i.D. 53	Rd 65x1/6 f	166	105	47	1320	65/53 FL

For hose clamps DIN 20 039 A, Typ SL (☺ page 253)



Single Connecting Nuts

Thread connection	L	B	Passage	Weight	Type No.
Rd 65 x 1/6 f	36	105	56.5	555	UM 65

Single Hose stems, flat sealing

Hose connection	L	Passage	Weight	Type No.
Hose i.D. 50	166	45	745	FT 50 L
Hose i.D. 53	166	48	765	FT 53 L

For hose clamps DIN 20039 A, type SL (☺ page 253)



Rubber rings for flat sealing hose stems

Resistance	L	D	Material	Temp. °C	Media	Shore A	Weight	Type No.
Oil	3	55	NBR	-40°C - +95°C	Compr. Air	65 °	2	ED 50 L

Double Nipples

Flat Sealing

- Nipples made of steel zinc-plated and yellow passivated (free of chrome VI)
- Suitable for complete screwings sets flat sealing (☺ above)
- To connect with machine/ tool for compressed air supply in mining and tunnelling

Materials

- Double Nipples: Steel zinc-plated and yellow passivated (free of chrome VI)

Max. Working Pressure	Temperature	Thread	Media	
PN 25 bar	- 40°C – + 95°C	ISO 228 / DIN 405	Compressed Air	1

Double nipples, flat sealing, with male/ male thread or rather male/ female thread

Thread connection	L	SW	L1	L2	Weight	Type No.
G 1 1/4 m - Rd 65x1/6 m	58	65	22	20	665	N 6554 A
G 1 1/2 m - Rd 65x1/6 m	58	65	22	20	675	N 6515 A
G 2 m - Rd 65x1/6 m	58	65	22	20	680	N 6520 A
G 2 f - Rd 65x1/6 m	55	65	25	20	650	N 6520 I
Rd 75x1/6 m - Rd 65x1/6 m	77	75	41	20	1192	N 6575 A

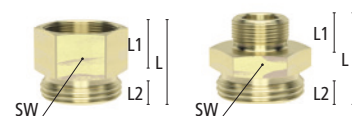

Flat Hose Screwings

100 %

- Safe
- Ergonomic
- Fast
- Reusable

- MODY-Safety-Screwing-Couplings, thread screwings and complete screwing sets with squeeze ring screwing for an absolute safe assembly of flat hoses for compressed air 3/4 to 1 1/2 inch
- The respective version (size of squeeze ring) always has to be adapted for the flat hose used
- Please indicate exact dimensions or samples of the hose before ordering
- **Can be used for compressed air supply in construction, mining and tunnelling**

Materials

- Claw, connecting nut: Malleable iron zinc-plated and yellow passivated (free of chrome VI)
- Hose connections, squeeze ring, squeeze nut: Steel zinc-plated and yellow passivated (free of chrome VI)
- Locking nut: Brass MS 58 plain
- Seals: NBR

Max. Working Pressure	Temperature	Thread	Norm	Media
PN 16/25 bar	-40°C – +100°C*	ISO 228/DIN 405	DIN 3238/20033	Air a.o.

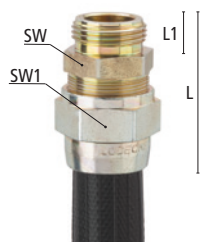

FlatLock Squeeze Ring Screwings with male thread connection

Hose connect.	Thread connect.	L	SW	L1	SW1	Passage	⊗	Weight	Type No.
Hose i.D. 19	G 3/4 m	65	32	13	32	17	5	205	G 34-19...FLTQ
Hose i.D. 25	G 1 m	65	36	14	41	22	5	290	G 10-25...FLTQ

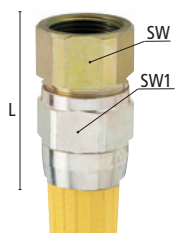

FlatLock Squeeze Ring Screwings with female thread connection

Hose connect.	Thread connect.	L	SW	SW1	Passage	⊗	Weight	Type No.
Hose i.D. 19	G 3/4 f	60	32	32	17	5	195	GI 34-19...FLTQ
Hose i.D. 25	G 1 f	61	36	41	22	5	265	GI 10-25...FLTQ

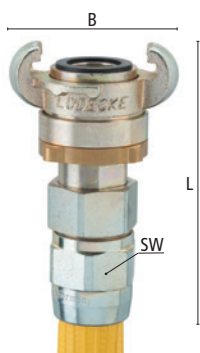

FlatLock Squeeze Ring Screwings with MODY-Safety-Screwing Coupling DIN 3238

Hose connection	L	SW	B	Passage	⊗	Weight	Type No.
Hose i.D. 19	118	32	63	17	5	550	SSG 19...FLTQ
Hose i.D. 25	129	41	63	17	5	630	SSG 25...FLTQ



FlatLock Squeeze Ring Screwing with complete screwing Set DIN 20033

Hose connect.	Thread connect.	L	SW	B	Cone	Passage	⊗	Weight	Type No.
Hose i.D. 38	RD 55x1/6 f	150	55	95	1:3	31	1	1500	55/38...FLTQ

Can be screwed with connecting nipples (☺ page 234/ 235)

Further fittings and hose dimensions on request.

*Subject to temperature and assembly method

This hose connection is available for the following coupling systems:

- MODY-Safety-Screwing Couplings DIN 3238
- Female and male thread screwings
- Complete Screwing Sets DIN 20 033

Attention:

Before you start, the inner diameter as well as the wall thickness of the flat hose always have to be adjusted to guarantee an exact and safe fit of the assembly. A size chart for this purpose is available on demand.

Hose connection manual:

Push the squeeze nut approximately 10 cm over the hose. The part bearing the **LUDECKE** logo must be up front.

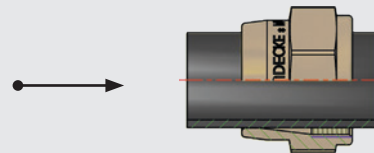

Also push the slotted squeeze ring over the straightly-cut hose with the cone up front. Make sure that the edge of the ring is flush with the hose end (labelled with the corresponding hose dimension).

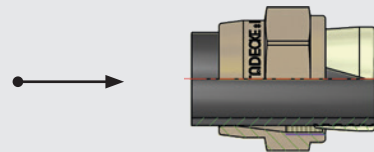

Push the screwing fitting with the stem up front into the hose until the connection thread matches the hose and squeeze ring end. The correct hose fit can be controlled at the squeeze ring slot.

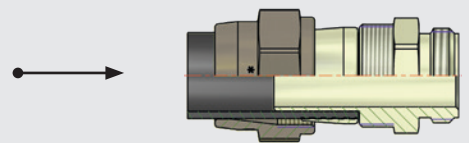

Pull the squeeze nut over the squeeze ring and the hose stem, then screw the squeeze nut manually in two turns onto the fitting.

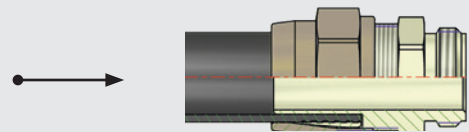

Afterwards secure the squeeze nut in a vice and screw the threaded joint with a spanner. The squeeze ring fixes the hose automatically due to the conical fit between squeeze nut and hose stem.

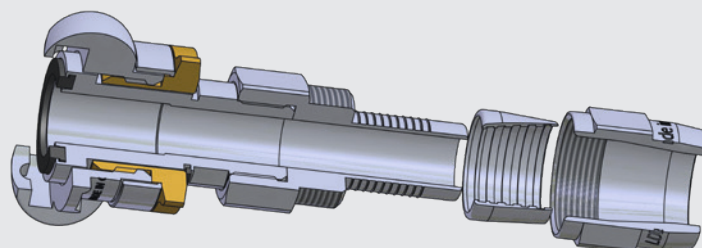
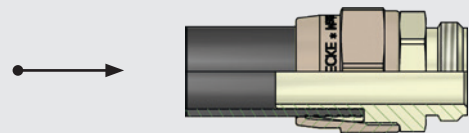

The FlatLock hose fittings are easy to assemble and offer a maximum of safety and ergonomics for the connection of thin-walled flat hoses - it is unlockable and reusable at any time.

Connecting Nipples

- Nipples made of steel or malleable iron zinc-plated and yellow passivated (free of chrome VI)
- Suitable for screwings (☉ page 230 - 232) DIN 8537/20033
- Worldwide used system for compressed air supply, water etc. in construction, mining and tunnelling

Materials

- Connecting nipples: Steel or malleable iron zinc-plated and yellow passivated (free of chrome VI)

Max. Working Pressure	Thread	Media
PN 25 bar	ISO 228 / DIN 405	Compressed Air / Water

Double Nipples DIN 8537/ 20036

Thread connection	L	SW	L1	Cone	☉	Weight	Type No.
2 x G 3/4 m	47	27	19	2 x 1:4	10	107	V 34 N
2 x G 3/4 m	47	32	19	2 x 1:4	10	125	V 34-32 N
2 x G 1 m	55	36	23	2 x 1:3	10	197	V 10 N
2 x Rd 32x1/8 m	55	32	23	2 x 1:3	10	163	V 32 N
2 x Rd 38x1/8 m	62	41	26	2 x 1:3	10	283	V 38 N
2 x Rd 46x1/6 m	70	46	30	2 x 1:3	1	410	V 46 N
2 x Rd 55x1/6 m	78	55	32	2 x 1:3	1	648	V 55 N
2 x Rd 62x1/6 m	88	65	36	2 x 1:3	1	869	V 62 N
2 x Rd 75x1/6 m	100	75	41	2 x 1:3	1	1490	V 75 N
2 x Rd 105x1/6 m	122	105	51	2 x 1:3	1	2990	V 105 N

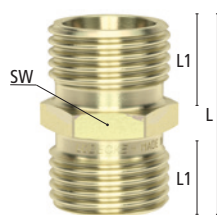

Sieve Nipples and Connecting Nipples DIN 20037

Thread connection	L	SW	L1	L2	Cone	Sieve	☉	Weight	Type No.
G 3/8 m - G 3/4 m	38	27	10	19	1:4	inner	10	84	N 38 IS
G 1/2 m - G 3/4 m	40	27	12.5	19	1:4	inner	10	85	N 23 IS
G 1/2 m - Rd 32x1/8 m	44	32	12.5	23	1:3	inner	10	126	N 82 IS
G 3/4 m - G 3/4 m	44	27	16	19	1:4	inner	10	104	N 34 IS
G 3/4 m - G 3/4 m	44	32	16	19	1:4	inner	10	120	N 34-32 IS
G 3/4 m - Rd 32x1/8 m	48	32	16	23	1:3	inner	10	135	N 32 IS
G 3/4 m - G 1 m	48	36	16	22	1:3	inner	10	173	N 341 IS
G 3/4 m - G 3/4 m	44	27	16.5	19	1:4	outer	10	100	N 34 AS
G 3/4 m - G 3/4 m	44	32	16.5	19	1:4	outer	10	120	N 34-32 AS
G 3/4 m - Rd 32x1/8 m	48	32	16.5	23	1:3	outer	10	130	N 32 AS
G 3/4 m - Rd 32x1/8 m	48	32	16	22	1:3	without	10	142	N 32 OS
G 1 m - Rd 32x1/8 m	49	36	16	23	1:3	inner	10	193	N 132 IS
G 1 m - Rd 38x1/8 m	54	41	18	26	1:3	without	10	252	N 18 OS
G 1 m - Rd 46x1/6 m	58	46	18	30	1:3	without	1	345	N 46-10 OS
G 1/4 m - Rd 46x1/6 m	58	46	18	30	1:3	without	1	331	N 46-54 OS
G 1 1/2 m - Rd 46x1/6 m	63	50	23	30	1:3	without	1	445	N 46 OS
G 1 1/4 m - Rd 55x1/6 m	63	55	18	32	1:3	without	1	536	N 55-54 OS
G 1 1/2 m - Rd 55x1/6 m	68	55	23	32	1:3	without	1	529	N 55 OS
G 2 m - Rd 55x1/6 m	70	65	25	32	1:3	without	1	860	N 55-20 OS
G 1 1/2 m - Rd 62x1/6 m	75	65	23	36	1:3	without	1	764	N 62 OS
G 2 m - Rd 62x1/6 m	75	65	25	36	1:3	without	1	820	N 62-20 OS
G 1 1/2 m - Rd 75x1/6 m	80	75	23	41	1:3	without	1	1220	N 75-15 OS
G 2 m - Rd 75x1/6 m	85	75	28	41	1:3	without	1	1196	N 75 OS
G 2 1/2 m - Rd 75x1/6 m	85	75	28	41	1:3	without	1	1387	N 75-25 OS
G 3 m - Rd 105x1/4 m	100	105	29	51	1:3	without	1	2290	N 105 OS

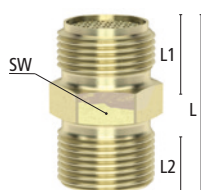

Connecting Nipples

Thread connection	L	SW	L1	L2	Cone	☉	Weight	Type No.
G 3/4 i - G 3/4 m	44	32	19	19	1:4	10	126	A 34 N
G 3/4 i - G 1 m	48	36	23	19	1:3	10	200	A 3410 N
G 3/4 i - Rd 32x1/8 m	47	32	21.5	19	1:3	10	136	A 32 N
G 3/4 i - Rd 38x1/8 m	48	41	25	19	1:3	10	270	A 38 N
G 1 i - Rd 32x1/8 m	50	41	23	22	1:3	10	206	A 1032 N
G 1 i - Rd 38x1/8 m	52	41	25	22	1:3	10	239	A 10 N

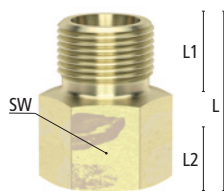

Connecting Nipples

Self-locking Nipple with brass valve

Thread connection	L	SW	Cone		Weight	Type No.
G 3/4 m - Rd 32x1/8 m	49	32	1:3	10	153	SN 32 ST

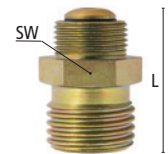

Combination Nipple

Thread connection	L	SW	L1	L2	Cone		Weight	Type No.
G 1 m - G 3/4 m	51	36	23	19	1:4	10	179	V 1034 N

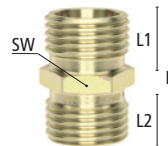

Hot Tar Screwings

- Hot tar screwing made of steel/ malleable iron zinc-plated and yellow passivated (free of chrome VI)
- Easy to operate by wing nut and a tapered stem with safety collar
- For hose connection on hot tar spraying devices, hot tar lances a.o.

Materials

- Tapered stem: Steel zinc-plated and yellow passivated (free of chrome VI)
- Wing nut: Malleable iron zinc-plated and yellow passivated (free of chrome VI)
- Nipple: Steel zinc-plated and yellow passivated (free of chrome VI)

Max. Working Pressure	Temperature	Thread	Media	
PN 25 bar	up to +200°C	ISO 228	hot tar	1

Hot Tar Screwing

Type	Connection	L	B	SW	L1	Passage	Weight	Type No.
Hot tar screwing complete	Hose i.D. 19 x G 3/4 f	112	165	32	60	15	506	HTV-SB*
Tapered stem	Hose i.D. 19, Cone 1:3					15	200	HTVT-SB*
Wing nut	G 1 1/4 f					-	207	HTVM
Nipple	G 3/4 f x G 1 1/4 m, Cone 1:3					-	99	HTVET

For hose clamps DIN 20039 B, Type SK 34 (© page 253)

Other sizes on request.

*with safety collar

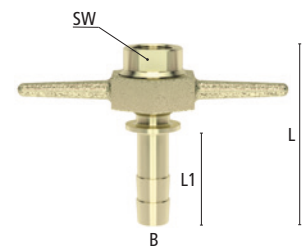

Thread Stems

- Thread stems made of steel zinc-plated and yellow passivated (free of chrome VI)
- Turned stem profile for perfect hose fit
- Maximum bore for maximum flow rate
- Suitable for compressed air supply and other media in construction, industry or plant engineering

Materials

- Thread stem: Steel zinc-plated and yellow passivated (free of chrome VI)

Max. Working Pressure	Thread	Media
PN 16 / 25 bar	ISO 228 / DIN 405	Compressed Air

Male thread stems without safety collar*

Hose connect.	Thread connect.	L	SW	L1	L2	Passage		Weight	Type No.	Euro
Hose i.D. 9	G 1/4 m	44	14	9	28	6	10	22	G 14-9 T	1.57
Hose i.D. 10	G 3/8 m	45	19	10	28	7	10	31	G 38-10 T	2.15
Hose i.D. 13	G 1/4 m	44	17	9	28	8.5	10	35	G 14-13 T	1.57
Hose i.D. 13	G 3/8 m	45	19	10	28	10	10	35	G 38-13 T	2.00
Hose i.D. 13	G 1/2 m	65	22	15	41	10	10	60	G 12-13 T	4.22
Hose i.D. 13	G 3/4 m	65	27	16	41	10	10	85	G 34-13 T	4.94
Hose i.D. 15	G 3/8 m	48	22	10	41	10	10	45	G 38-15 T	4.44
Hose i.D. 15	G 1/2 m	65	22	15	41	12	10	62	G 12-15 T	4.22
Hose i.D. 15	G 3/4 m	65	27	16	41	12	10	92	G 34-15 T	5.01
Hose i.D. 19	G 1/2 m	65	22	15	41	14	10	82	G 12-19 T	3.88
Hose i.D. 19	G 3/4 m	65	27	16	41	15	10	99	G 34-19 T	4.64
Hose i.D. 25	G 3/4 m	65	27	16	39	19	10	118	G 34-25 T	5.01

*PN 16 bar

For hose clamps DIN 20039 A, type SL (☺ page 253)

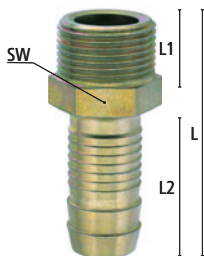

Male thread stems with safety collar**

Hose connect.	Thread connect.	L	SW	L1	L2	∅Collar	Passage		Weight	Type No.	Euro
Hose i.D. 13	G 1/2 m	73	22	40	15	22	10	10	75	G 12-13 TB	5.87
Hose i.D. 19	G 3/4 m	72	32	40	15	32	15	10	142	G 34-19 TB	6.01
Hose i.D. 19	G 1 m	74	36	40	17	32	15	10	175	G 10-19 T	7.39
Hose i.D. 25	G 1 m	80	36	41	17	36	20	10	220	G 10-25 T	7.39
Hose i.D. 25	G 1 1/4 m	90	46	48	18	39	20	5	321	G 54-25 T	14.92
Hose i.D. 32	G 1 1/4 m	92	46	48	20	45	25	5	406	G 54-32 T	14.92
Hose i.D. 38	G 1 1/2 m	100	55	51	22	53	33	1	532	G 15-38 T	16.64
Hose i.D. 42	G 1 1/2 m	100	55	51	22	54	35	1	571	G 15-42 T	17.36
Hose i.D. 50	G 2 m	125	65	72	25	64	42	1	943	G 20-50 T	38.14
Hose i.D. 53	G 2 m	125	75	72	25	74	44	1	1123	G 20-53 T	49.18
Hose i.D. 75	G 3 m	185	90	120	30	95	68	1	2033	G 30-75 T	112.57

**PN 25 bar

For hose clamps DIN 20039 B, type SK (☺ page 253)

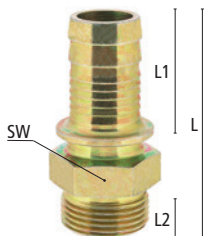

Female thread stems with safety collar**

Hose connect.	Thread connect.	L	SW	L1	L2	∅Collar	Passage		Weight	Type No.	Euro
Hose i.D. 19	G 3/4 f	71	32	19	40	32	15	10	134	G 34-19 TI	6.60
Hose i.D. 19	G 1 f	73	41	20	40	32	15	10	197	G 10-19 TI	9.04
Hose i.D. 25	G 1 f	75	41	20	41	36	20	10	227	G 10-25 TI	9.59
Hose i.D. 25	G 1 1/4 f	80	50	23	41	36	20	5	323	G 54-25 TI	15.47
Hose i.D. 32	G 1 1/4 f	86	50	23	48	45	25	5	390	G 54-32 TI	16.34

**PN 25 bar

For hose clamps DIN 20039 B, type SK (☺ page 253)

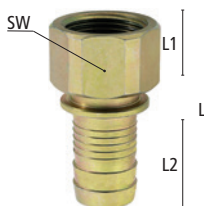

Hose Connections and Thread Ferrule Screwings

- Hose connections made of steel zinc-plated and yellow passivated (free of chrome VI)
- Simple and safe hose connection with turned stem profile
- Thread ferrule screwings can be loosened and reused at any time
- Maximum bore for maximum flow rate
- Suitable for compressed air and other media in various applications

Materials

- Connection, screwing: Steel zinc-plated and yellow passivated (free of chrome VI)

Max. Working Pressure	Media
PN 16 / 25 bar	Compressed Air a.o.

Hose Connections DIN 20038 without safety collar*

Hose connection	L	D	Passage	⊠	Weight	Type No.	Euro
2 x Hose i.D. 10	75	11	8	10	25	SV 10 R	2.30
2 x Hose i.D. 13	80	13.5	9	10	44	SV 13 R	1.63
2 x Hose i.D. 15	105	17	12,5	10	73	SV 15 R	1.63
2 x Hose i.D. 19	105	21	16	10	93	SV 19 R	1.72
2 x Hose i.D. 25	160	26.5	22	10	166	SV 25 R	2.30
2 x Hose i.D. 32	175	33.5	27	5	351	SV 32 R	4.44
2 x Hose i.D. 38	215	40	33	5	430	SV 38 R	8.46
2 x Hose i.D. 50	225	51	45	1	670	SV 50 R	14.07
2 x Hose i.D. 53	225	54	46	1	960	SV 53 R	15.62

*PN 16 bar

For hose clamps DIN 20039 A, typ SL (☺ page 253)



Hose Connections DIN 20038 with safety collar**

Hose connection	L	D	L1	∅Collar	Passage	⊠	Weight	Type No.	Euro
2 x Hose i.D. 13	80	13.5	38.5	25	9	10	48	SV 13 R/S	3.88
2 x Hose i.D. 15	105	17	50.5	30	12.5	10	77	SV 15 R/S	3.99
2 x Hose i.D. 19	105	21	51.5	34	16	10	107	SV 19 R/S	3.99
2 x Hose i.D. 25	160	26.5	78.5	42	22	10	170	SV 25 R/S	4.87
2 x Hose i.D. 32	175	33.5	60	50	27	5	382	SV 32 R/S	8.02
2 x Hose i.D. 38	215	40	96	56	33	5	490	SV 38 R/S	12.32
2 x Hose i.D. 50	225	51	110	78	45	1	870	SV 50 R/S	18.50
2 x Hose i.D. 53	225	54	110	78	46	1	1126	SV 53 R/S	20.36
2 x Hose i.D. 75	250	76	120	110	68	1	1811	SV 75 R/S	42.74

**PN 25 bar

For hose clamps DIN 20039 B, type SK (☺ page 253)

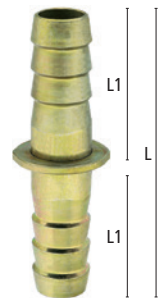

Male thread ferrule screwings (according to DIN EN 14424)*

Hose connect.	Thread connect.	L	SW	L1	SW1	L2	Passage	⊠	Weight	Type No.	Euro
Hose 13x3	G 1/2 m	50	22	12	22	27	11	10	102	G 12-133 TQ	7.74
Hose 13x5	G 1/2 m	50	22	12	22	27	11	10	104	G 12-135 TQ	7.74
Hose 15x5	G 3/4 m	52	27	13	27	30	13	10	140	G 34-155 TQ	10.56
Hose 19x5	G 3/4 m	52	27	13	27	30	17	10	170	G 34-195 TQ	10.56
Hose 19x6	G 3/4 m	52	27	13	27	30	17	10	180	G 34-196 TQ	10.56
Hose 25x5	G 1 m	58	36	14	36	36	22	10	220	G 10-255 TQ	12.02
Hose 25x7	G 1 m	58	36	14	36	36	22	10	230	G 10-257 TQ	12.02

*PN 16 bar

Assembly instructions for thread ferrules (www.luedecke.com)

Other sizes on request.

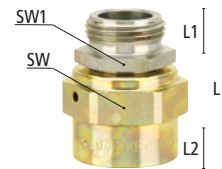

Mortar Couplings and Plugs



For pumping mortar, plaster or screed, **LUDECKE** has developed extremely sturdy and robust mortar couplings and plugs. They guarantee excellent operating safety and maximum material flow to your machine.

Mortar couplings are lever couplings - however, not compatible with standard Kamlok couplings.

Connecting follows a simple principle: female and male parts made of malleable cast iron or steel are locked by two handles. You only have to pay attention to the two different measuring systems used in the market (22 and 23.5 in size).

Advantages:

- High-quality materials
- Robust, reliable, absolutely leakage-proof and durable
- Easy and fast handling
- Swivel version for permanent floating of mostly rigid mortar hoses
- Different sizes, versions and connection types

Broad Range

LUDECKE mortar couplings are available in different versions (rigid/ swivelling), in various materials (aluminium, malleable cast iron, steel) and allow for great flexibility.



Reliable Quality

At a working pressure of 50 bar, a thorough assembly on the hose barb is necessary. We recommend couplings with swivel function at least at one point of the hose line.

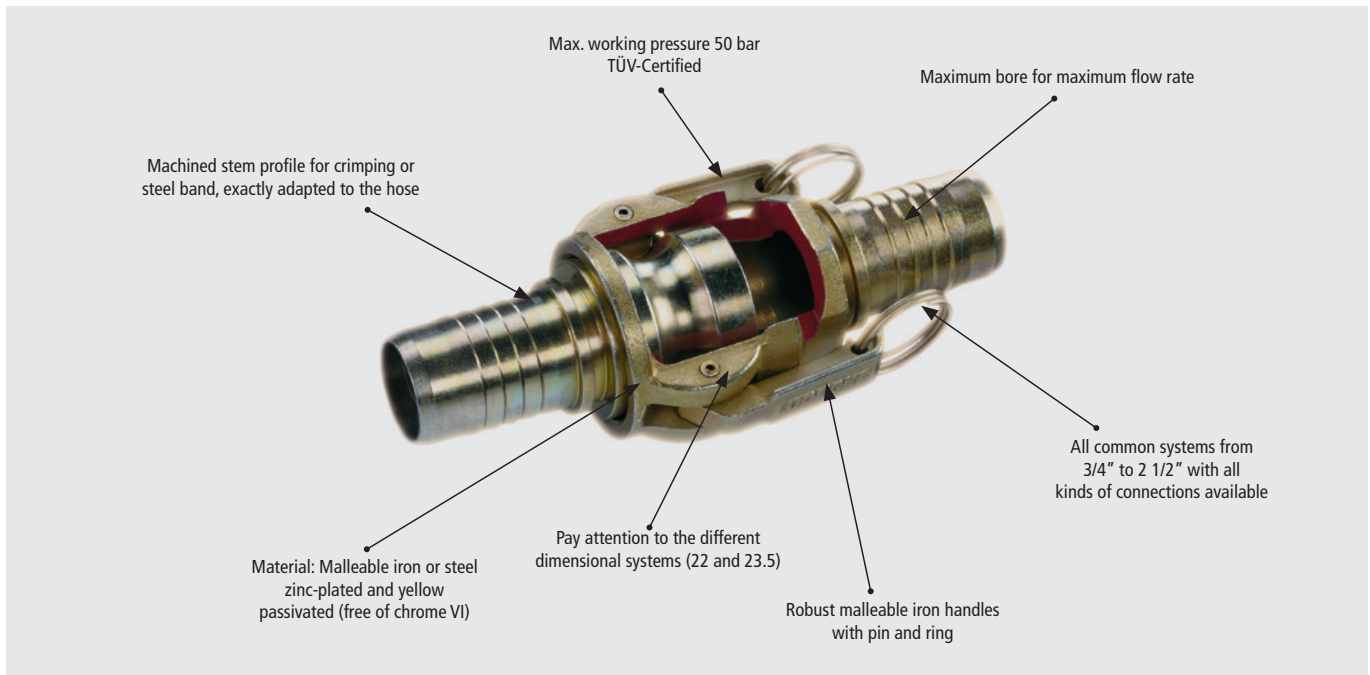

Overview of Mortar Couplings

Standard	For Hydraulic Hose Crimping	Made of Aluminium	System „Mai“
22 and 23.5	22 and 23.5	X25	Mai



Materials				
Coupling:	Malleable iron (zinc-plated + yellow pass.)	Malleable iron (zinc-plated + yellow pass.)	Aluminium	Malleable iron (zinc-plated + yellow pass.)
Plug:	Steel/ Malleable iron (zinc-plated + yellow pass.)	Steel (zinc-plated + yellow pass.)	-	Steel (zinc-plated + yellow pass.)
Connector:	Steel (zinc-plated + yellow pass.)	Steel (zinc-plated + yellow pass.)	Aluminium	-
Handle:	Malleable iron (zinc-plated + yellow pass.)	Malleable iron (zinc-plated + yellow pass.)	Malleable iron (zinc-plated + yellow pass.)	Malleable iron (zinc-plated + yellow pass.)
Seals:	NBR	NBR	NBR, PTFE, PUR	NBR
Max. Working Pressure:	PN 50 bar	PN 50 bar	PN 40 bar	PN 50 bar
Temperature:	-40°C – +90°C	-40°C – +90°C	-40°C – +90°C	-40°C – +90°C
Thread types:	all types	all types	ISO 228	ISO 228
Version:	Rigid/ swivelling	Rigid/ swivelling	Rigid/ swivelling	Rigid
Page:	240	244	246	247

Mortar Couplings

made of Malleable Iron/ Steel, rigid and swivelling - Standard Version



- Couplings made of malleable iron/ steel zinc-plated and yellow passivated (free of chrome VI)
- Turned stem profile for perfect hose fit
(On request according to drawing or hose sample)
- Attention: Use same system!
- To supply mortar, concrete or screed at pumps, spraying devices, plastering machines, etc.
- Other swivelling types on request!
- Swivelling version made of three parts, lead in teflon slide, absolutely leakage-proof for long lifetime
- Permanent floating of mostly rigid mortar hoses

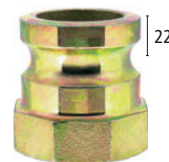

System 22
(for all type-sizes except 42)

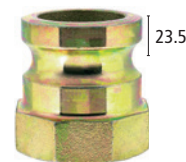

System 23.5
(only at type-sizes 35 and 50!)

Max. Working Pressure	Temperature	Thread	TÜV-certified	Media	
PN 50 bar	-40°C – +90°C	all types	all types	Mortar/concrete	1

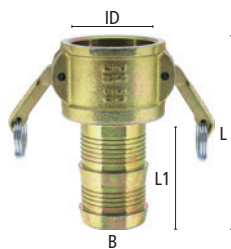

swivelling

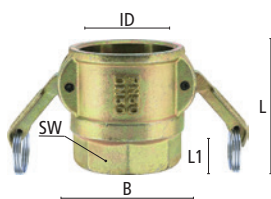
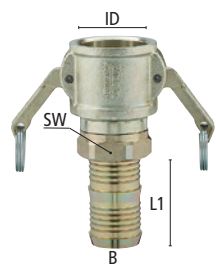

swivelling

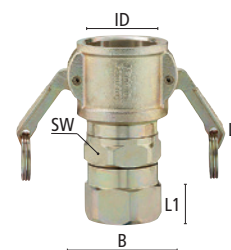

swivelling

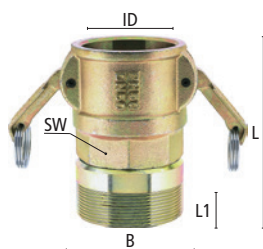

Couplings with hose stem (full passage)

Hose connect.	L	B	T-Size	ID	L1	Passage	Version	Weight	System 22		System 23.5	
									Type No.	Type No.	Type No.	Type No.
Hose i.D. 25	120	55	25	35.5	67	20	rigid, 1 Handle	477	MST 25		Same dimension	
Hose i.D. 25	138	74	X25	42	64	25	rigid, 2 Handles	778	MST-X25		Same dimension	
Hose i.D. 35	132	77	35	51	75	29	rigid, 2 Handles	795	MST 35		MST 35-N	
Hose i.D. 35	152	77	35	51	68	30	swivelling, 2 Handles	970	MST 35-DR		MST 35-DR-N	
Hose i.D. 38	146	77	35	51	64	33	rigid, 2 Handles	903	MST 38/35		MST 38/35-N	
Hose i.D. 42	144	84	42	54	67	38	rigid, 2 Handles	960	MST 42**		Same dimension	
Hose i.D. 50	140	94	50	64	83	43	rigid, 2 Handles	1195	MST 50		MST 50-N	
Hose i.D. 65	185	105	65	74	98	56	rigid, 2 Handles	2172	MST 65*		Same dimension	

Couplings with hose stem (reduced passage)

Hose connect.	L	SW	B	T-Size	ID	L1	Passage	Version	Weight	Type No.	Type No.
Hose i.D. 19	122	41	55	25	35.5	50	16	rigid, 1 Handle	512	MST 25/19 R	Same dimension
Hose i.D. 19	125	41	74	X25	42	50	16	rigid, 2 Handles	760	MST-X25/19 R	Same dimension
Hose i.D. 25	138	50	77	35	51	64	24	rigid, 2 Handles	783	MST 35/25 R	MST 35/25 R-N
Hose i.D. 35	160	70	94	50	64	77	30	rigid, 2 Handles	1495	MST 50/35 R	MST 50/35 R-N
Hose i.D. 42	160	70	94	50	64	77	38	rigid, 2 Handles	1510	MST 50/42 R	MST 50/42 R-N

Couplings with female thread

Hose connect.	L	SW	B	T-Size	ID	L1	Passage	Version	Weight	Type No.	Type No.
G 1 f	70	41	55	25	35.5	18	24	rigid, 1 Handle	410	MIG 10/25	Same dimension
G 1 f	73,5	41	74	X25	42	19	25	rigid, 2 Handles	652	MIG 10-X25	Same dimension
G 1 f	74	50	77	35	51	19	30	rigid, 2 Handles	770	MIG 10/35	MIG 10/35-N
G 1 1/4 f	74	50	77	35	51	19	35	rigid, 2 Handles	648	MIG 54/35	MIG 54/35-N
G 1 1/4 f	125	50	77	35	51	23	33	swivelling, 2 Handles	1170	MIG 54/35-DR	MIG 54/35-N-DR
G 1 1/2 f	74	56	77	35	51	19	35	rigid, 2 Handles	766	MIG 15/35	MIG 15/35-N
G 1 1/2 f	66	60	84	42	54	19	38	rigid, 2 Handles	730	MIG 15/42**	Same dimension
G 2 f	79	70	94	50	64	26	50	rigid, 2 Handles	990	MIG 20/50	MIG 20/50-N
G 2 f	135	70	94	50	64	25	43	swivelling, 2 Handles	1550	MIG 20/50-DR	MIG 20/50-DR-N
G 2 1/2 f	81	84	105	65	74	26	58	rigid, 2 Handles	1027	MIG 25/65*	Same dimension

Couplings with male thread

Hose connect.	L	SW	B	T-Size	ID	L1	Passage	Version	Weight	Type No.	Type No.
G 1 m	91	41	55	25	35.5	17	24	rigid, 1 Handle	485	MAG 10/25	Same dimension
G 1 m	90	41	74	X25	42	16	25	rigid, 2 Handles	735	MAG 10-X25	Same dimension
G 1 1/4 m	93	50	77	35	51	19	33	rigid, 2 Handles	793	MAG 54/35	MAG 54/35-N
G 1 1/2 m	98	60	84	42	54	22	38	rigid, 2 Handles	935	MAG 15/42**	Same dimension
G 2 m	113	70	94	50	64	25	47	rigid, 2 Handles	1420	MAG 20/50	MAG 20/50-N
G 2 1/2 m	119	84	94	50	64	25	50	rigid, 2 Handles	1620	MAG 25/50	MAG 25/50-N

*max. working pressure for type-size 65 PN 25 bar

**type-size 42 system 17.5 derived from DIN EN 14420-7, DN 40

Mortar Couplings

Materials

- Coupling, handle: Malleable iron zinc-plated and yellow passivated (free of chrome VI)
- Hose stem: Steel zinc-plated and yellow passivated (free of chrome VI)
- Seals: NBR

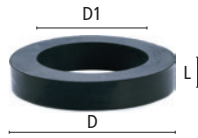
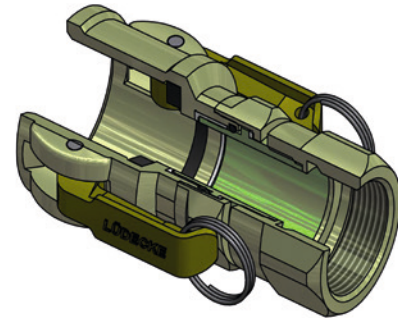

O-ring made of NBR
55° Shore A



Handle with safety-ring
and slotted pin made of malleable
iron zinc-plated and yellow
passivated (free of chrome VI)

Suitable spare parts
(Packing Unit: 10 pcs.)

L	D	D1	Weight	Type No.	Weight	Type No.
6	36	24.5	5	MDR 25	60	MNH-628
6	43.5	28.5	5	MDR-X25	60	MNH-630
6	53.5	36.5	5	MDR 35	60	MNH-628
6	53.5	36.5	5	MDR 35	60	MNH-628
6	53.5	36.5	5	MDR 35	60	MNH-628
6.5	55	41	6	MDR 42	60	MNH-628
6	67	51	7	MDR 50	60	MNH-636
6.3	76	61	10	MDR 65	60	MNH-636

L	D	D1	Weight	Type No.	Weight	Type No.
6	36	24.5	5	MDR 25	60	MNH-628
6	43.5	28.5	5	MDR-X25	60	MNH-630
6	53.5	36.5	5	MDR 35	60	MNH-628
6	67	51	7	MDR 50	60	MNH-636
6	67	51	7	MDR 50	60	MNH-636

L	D	D1	Weight	Type No.	Weight	Type No.
6	36	24.5	5	MDR 25	60	MNH-628
6	43.5	28.5	5	MDR-X25	60	MNH-630
6	53.5	36.5	5	MDR 35	60	MNH-628
6	53.5	36.5	5	MDR 35	60	MNH-628
6	53.5	36.5	5	MDR 35	60	MNH-628
6	53.5	36.5	5	MDR 35	60	MNH-628
6.5	55	41	6	MDR 42	60	MNH-628
6	67	51	7	MDR 50	60	MNH-636
6	67	51	7	MDR 50	60	MNH-636
6.3	76	61	10	MDR 65	60	MNH-636

L	D	D1	Weight	Type No.	Weight	Type No.
6	36	24.5	5	MDR 25	60	MNH-628
6	43.5	28.5	5	MDR-X25	60	MNH-630
6	53.5	36.5	5	MDR 35	60	MNH-628
6.5	55	41	6	MDR 42	60	MNH-628
6	67	51	7	MDR 50	60	MNH-636
6	67	51	7	MDR 50	60	MNH-636

Mortar Plugs

made of Malleable Iron/ Steel, rigid and swivelling - Standard Version



- Plugs made of malleable iron/ steel zinc plated and yellow passivated (free of chrome VI)
- Turned stem profile for perfect hose fit
(On request according to drawing or hose sample)
- Attention: Use same system!
- To supply mortar, concrete or screed at pumps, spraying devices, plastering machines, etc.
- Other swivelling types on request!
- Swivelling version made of three parts, lead in teflon slide, absolutely leakage-proof for long lifetime
- Permanent floating of mostly rigid mortar hoses

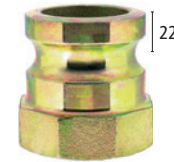

System 22
(for all type-sizes except 42)

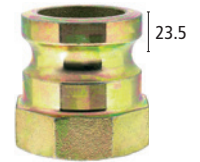

System 23.5
(only at type-sizes 35 and 50!)

Max. Working Pressure	Temperature	Thread	TÜV-certified	Media	
PN 50 bar	-40°C – +90°C	ISO 228	all types	Mortar/ concrete	1

Plugs with hose stem (full passage)								System 22	System 23.5
Hose connect.	L	T.-Size	AD	L1	Passage	Version	Weight	Type No.	Type No.
Hose i.D. 25	110	25	35	64	20	rigid	270	VST 25	Same dimension
Hose i.D. 25	120	X25	41	65	24	rigid	385	VST-X25	Same dimension
Hose i.D. 25	125	X25	41	60	24	swivelling	420	VST-X25-DR	Same dimension
Hose i.D. 35	120	35	49.5	70	30	rigid	515	VST 35	VST 35-N
Hose i.D. 35	146	35	49.5	68	30	swivelling	740	VST 35-DR	VST 35-DR-N
Hose i.D. 38	120	35	49.5	70	33	rigid	470	VST 38/35	VST 38/35-N
Hose i.D. 42	120	42	53	77	38	rigid	450	VST 42**	Same dimension
Hose i.D. 50	140	50	63	77.5	42	rigid	925	VST 50	VST 50-N
Hose i.D. 50	170	50	63	82	43	swivelling	1230	VST 50-DR	VST 50-DR-N
Hose i.D. 65	156	65	73	98	56	rigid	1352	VST 65*	Same dimension

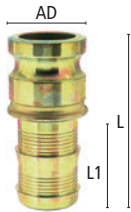

Plugs with hose stem (reduced passage)									
Hose connect.	L	T.-Size	AD	L1	Passage	Version	Weight	Type No.	Type No.
Hose i.D. 19	100	X25	41	50	16	rigid	325	VST-X25/19R	Same dimension
Hose i.D. 25	115	35	49.5	64	20	rigid	545	VST 35/25 R	VST 35/25 R-N
Hose i.D. 35	121	50	63	70	30	rigid	830	VST 50/35 R	VST 50/35 R-N
Hose i.D. 42	121	50	63	70	38	rigid	757	VST 50/42 R	VST 50/42 R-N

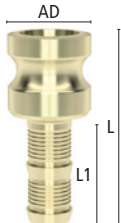

Plugs with female thread										
Thread connect.	L	SW	T.-Size	AD	L1	Passage	Version	Weight	Type No.	Type No.
G 1 f	67	41	25	35	15	20	rigid	280	VIG 10/25	Same dimension
G 1 f	67	41	X25	41	15	25	rigid	345	VIG 10-X25	Same dimension
G 1 f	106	41	X25	41	21	23	swivelling	610	VIG 10-X25-DR	Same dimension
G 1 1/4 f	67	50	X25	41	16	25	rigid	386	VIG 54-X25	Same dimension
G 1 f	63	50	35	49.5	20	30	rigid	521	VIG 10/35	VIG 10/35-N
G 1 1/4 f	68	50	35	49.5	16	33	rigid	461	VIG 54/35	VIG 54/35-N
G 1 1/4 f	120	50	35	49.5	23	33	swivelling	840	VIG 54/35-DR	VIG 54/35-DR-N
G 1 1/2 f	68	55	35	49.5	19	33	rigid	453	VIG 15/35	VIG 15/35-N
G 2 f	74	70	35	49.5	20	33	rigid	665	VIG 20/35	VIG 20/35-N
G 1 1/2 f	62	55	42	53	16	38	rigid	420	VIG 15/42**	Same dimension
G 1 1/4 f	64	65	50	63	22	35	rigid	820	VIG 54/50	VIG 54/50-N
G 1 1/2 f	64	65	50	63	22	44	rigid	678	VIG 15/50	VIG 15/50-N
G 2 f	71	70	50	63	20	45	rigid	620	VIG 20/50	VIG 20/50-N
G 2 f	130	70	50	63	25	43	swivelling	1040	VIG 20/50-DR	VIG 20/50-DR-N
G 2 1/2 f	78	85	50	63	25	45	rigid	960	VIG 25/50	VIG 25/50-N
G 2 1/2 f	78	85	65	73	25	56	rigid	999	VIG 25/65*	Same dimension

*max. working pressure for type-size 65 PN 25 bar

**type-size 42 system 17.5 derived from DIN EN 14420-7, DN 40

Other swivelling types on request

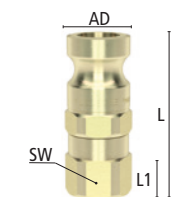
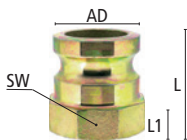

Materials

- Plug: Steel/ malleable iron zinc-plated and yellow passivated (free of chrome VI)
- Screwing stem: Steel zinc-plated and yellow passivated (free of chrome VI)
- Coupling, handle: Malleable iron zinc-plated and yellow passivated (free of chrome VI)
- Seals: NBR

									System 22	System 23.5
Plugs with male thread									Type No.	Type No.
Thread connect.	L	SW	Type-Size	AD	L1	Version	Passage	Weight		
G 1 m	76	41	25	35	17	rigid	20	356	VAG 10/25	Same dimension
G 1 m	76	41	X25	41	17	rigid	24	382	VAG 10-X25	Same dimension
G 1 1/4 m	83	50	35	49.5	20	rigid	33	527	VAG 54/35	VAG 54/35-N
G 1 1/2 m	77	55	42	53	20	rigid	38	525	VAG 15/42**	Same dimension
G 2 m	90	65	50	63	25	rigid	45	950	VAG 20/50	VAG 20/50-N

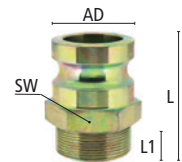

Plugs on both sides – system-reducing plug							
Type-Size	L	AD	AD1	Passage	Weight	Type No.	Type No.
X25 - 25	90	41	35	20	448	VR X25/25	Same dimension
35 - 25	97	49.5	35	20	654	VR 35-25	VR 35-N-25
35 - X25	100	49.5	41	25	690	VR 35-X25	VR 35-N-X25
42 - X25	90	53	41	25	620	VR 42/X25**	Same dimension
42 - 35	90	53	49.5	33	650	VR 42/35**	VR 42/35-N
50 - X25	100	63	41	25	955	VR 50-X25	VR 50-N-X25
50 - 35	100	63	49.5	33	955	VR 50-35	VR 50-N/35-N
50 - 42	95	63	53	38	983	VR 50/42**	VR 50-N/42

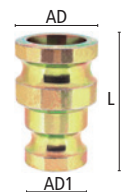

Screwing stems for female thread couplings and plugs							
Hose connect.	Thread connect.	L	L1	L2	Passage	Weight	Type No.
Hose i.D. 19	G 1 m	70	18	50	16	106	MST-X25/19T
Hose i.D. 25	G 1 m	83.5	18	64	24	128	MST-X25T
Hose i.D. 35	G 1 1/4 m	91	19	70	30	236	MST-35T
Hose i.D. 38	G 1 1/4 m	91	20	70	33	210	MST-38/35T
Hose i.D. 35	G 2 m	107	27	77	30	506	MST-50/35T
Hose i.D. 42	G 1 1/2 m	97	19	77	38	259	MST-42T
Hose i.D. 42	G 2 m	106	26	77	38	428	MST-50/42T
Hose i.D. 50	G 2 m	110	26	82	42	510	MST-50T
Hose i.D. 65	G 2 1/2 m	130	25	98	56	1145	MST-65T



Couplings with plug – system-reducing-adapters								
Type-Size	L	B	ID	AD	Passage	Weight	Type No.	Type No.
X25 - 25	132	74	42	35	20	993	MSA-X25/25	Same dimension
35 - X25	133	77	51	41	24	1154	MSA 35/X25	MSA 35-N/X25
42 - 35	135	84	54	49	33	1270	MSA 42/35**	MSA 42/35-N
50 - 35	133	94	64	49	33	1580	MSA 50/35	MSA 50-N/35-N
50 - 42	133	94	64	53	38	1585	MSA 50/42**	MSA 50-N/42

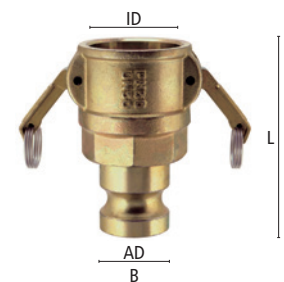

*handles and seals as spare parts (© page 241)

**type-size 42 system 17.5 derived from DIN EN 14420-7, DN 40

Mortar Couplings and Plugs

made of Malleable Iron/ Steel, rigid and swivelling, for Hydraulic Hose Crimping



- For hydraulic hose crimping with ferrules made of steel
- Safe, clean and unremovable connection of hose and coupling
- Couplings and Plugs made of malleable iron/ steel zinc-plated and yellow passivated (free of chrome VI)
- Turned stem profile for perfect hose fit
- Stem profiles, ferrules and crimping dimensions for special hoses on request according to drawings or hose samples
- Swivelling version made of three parts, lead in teflon slide, absolutely leakage-proof for long lifetime
- Permanent floating of mostly rigid mortar hoses

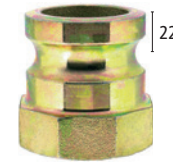

System 22
(for all type-sizes except 42)

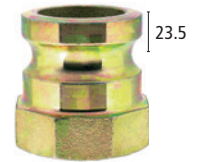

System 23.5
(only at type-sizes 35 and 50!)

Max. Working Pressure	Temperature	Thread	TÜV-certified	Media	
PN 50 bar	-40°C – +90°C	ISO 228	all types	Mortar/concrete	1

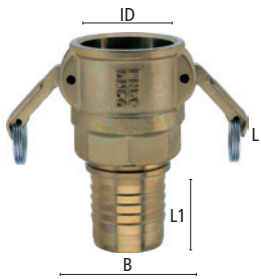

							System 22		System 23.5	
Couplings with hose stem (full passage)							Type No.	Type No.		
Hose connect.	L	B	Type-Size	ID	Passage	Version	Ferrule	Weight	Type No.	Type No.
Hose 25x7	125	55	25	35.5	24	rigid,1 Handle	PH-X25	540	MSTP 25*	Same dimension
Hose 25x7	128	74	X25	42	24	rigid,2 Handles	PH-X25	780	MSTP-X25	Same dimension
Hose 35x7	134	77	35	51	30	rigid,2 Handles	PH-35	910	MSTP 35	MSTP 35-N
Hose 38x7	135	77	35	51	33	rigid,2 Handles	PH-38	910	MSTP 38/35	MSTP 38/35-N
Hose 42x7	127	84	42	54	38	rigid,2 Handles	PH-42	974	MSTP 42**	Same dimension
Hose 50x9	145	94	50	64	44	rigid,2 Handles	PH-50	1480	MSTP 50	MSTP 50-N

Couplings with hose stem (reduced passage)										
Hose connect.	L	B	Type-Size	ID	Passage	Version	Ferrule	Weight	Type No.	Type No.
Hose 19x6	125	74	X25	42	15	rigid, 2 Handles	PH-19	780	MSTP-X25/19R	Same dimension
Hose 25x7	129	77	35	51	24	rigid, 2 Handles	PH-X25	870	MSTP 35/25 R	MSTP 35/25 R-N
Hose 35x7	140	94	50	64	30	rigid, 2 Handles	PH-35	1480	MSTP 50/35 R	MSTP 50/35 R-N

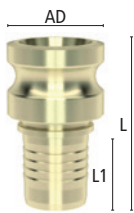

Plugs with hose stem (full passage)											
Hose connect.	L	SW	T-Size	AD	L1	Pass.	Version	Ferrule	Weight	Type No.	Type No.
Hose 25x7	100	-	25	35.5	44	20	rigid	PH-X25	305	VSTP 25	Same dimension
Hose 25x7	104	-	X25	41	44	24	rigid	PH-X25	339	VSTP-X25	Same dimension
Hose 25x7	115	41	X25	41	45.5	24	swivelling	PH-X25 DR	380	VSTP-X25-DR	Same dimension
Hose 35x7	107	-	35	49.5	50	30	rigid	PH-35	522	VSTP 35	VSTP 35-N
Hose 35x7	135	50	35	49.5	50	30	swivelling	PH-35 DR	740	VSTP 35-DR	VSTP 35-N-DR
Hose 38x7	107	-	35	49.5	50	33	rigid	PH-38	472	VSTP 38/35	VSTP 38/35-N
Hose 42x7	106	-	42	54	50	38	rigid	PH-42	475	VSTP 42**	Same dimension
Hose 50x9	113	-	50	63	55	44	rigid	PH-50	758	VSTP 50	VSTP 50-N
Hose 50x9	145	65	50	63	55	43	swivelling	PH-50 DR	1020	VSTP 50-DR	VSTP 50-N-DR

Plugs with hose stem (reduced passage)										
Hose connect.	L	Type-Size	ID	L1	Passage	Version	Ferrule	Weight	Type No.	Type No.
Hose 19x6	95	25	35.5	40	15	rigid	PH-19	238	VSTP 25/19 R	Same dimension
Hose 19x6	100	X25	41	40	15	rigid	PH-19	345	VSTP-X25/19R	Same dimension
Hose 25x7	102	35	49.5	45	24	rigid	PH-X25	490	VSTP 35/25 R	VSTP 35/25 R-N
Hose 35x7	107	50	63	50	30	rigid	PH-35	820	VSTP 50/35 R	VSTP 50/35 R-N
Hose 42x7	108	50	63	45	38	rigid	PH-42	741	VSTP 50/42 R	VSTP 50/42 R-N

Other swivelling types on request

*type-size 25 with one handle

**type-size 42 system 17.5 derived from DIN EN 14420-7, DN 40

Mortar Couplings and Plugs

Materials

- Coupling, handle: Malleable iron zinc-plated and yellow passivated (free of chrome VI)
- Plug, hose stem: Steel zinc-plated and yellow passivated (free of chrome VI)
- Seals: NBR

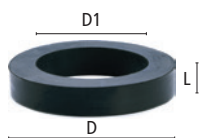

Seals of NBR
55° Shore A



Handle with safety-ring and slotted pin of malleable iron zinc-plated and yellow passivated (free of chrome VI)

Suitable spare parts
(Packing Unit: 10 pcs.)

L	D	D1	Weight	Type No.	Weight	Type No.
6	36	24.5	5	MDR 25	60	MNH-628
6	43.5	28.5	5	MDR-X25	60	MNH-630
6	53.5	36.5	5	MDR 35	60	MNH-628
6	53.5	36.5	5	MDR 35	60	MNH-628
6.5	55	41	6	MDR 42	60	MNH-628
6	67	51	7	MDR 50	60	MNH-636

L	D	D1	Weight	Type No.	Weight	Type No.
6	43.5	28.5	5	MDR-X25	60	MNH-630
6	53.5	36.5	5	MDR 35	60	MNH-628
6	67	51	7	MDR 50	60	MNH-636

Crimping Ferrules made of turned steel for hydraulic crimping (inner profile exactly suitable to hose stem profile)

Hose connect.	L	D	Type-size	D1	D2	Version	Weight	Type No.
Hose 19x6	40	38	19/25	31.5	24.5	rigid	102	PH-19
Hose 25x7	50	50	X25	41	33	rigid	218	PH-X25
Hose 25x7	50	50	X25	41	31.3	swivelling	220	PH-X25 DR
Hose 35x7	55	58	35	49	42.5	rigid	275	PH-35
Hose 35x7	55	58	35	49	41	swivelling	280	PH-35 DR
Hose 38x7	55	61	35	53	45.5	rigid	259	PH-38
Hose 42x7	55	65	42	56	50.5	rigid	313	PH-42
Hose 50x9	60	75	50	68.5	59.5	rigid	302	PH-50
Hose 50x9	60	75	50	68.5	57	swivelling	310	PH-50 DR



Screwing Stems for hydraulic crimping

Hose connect.	Thread connect.	L	D	L1	L2	Passage	Ferrule	Weight	Type No.
Hose 19x6	G 1 m	69.5	24	40	18	15	PH-19	125	MSTP-X25/19T
Hose 25x7	G 1 m	73.5	32.5	45	18	24	PH-X25	120	MSTP-X25T
Hose 35x7	G 1 1/4 m	80	42	50	19	30	PH-35	218	MSTP-35T
Hose 38x7	G 1 1/4 m	80	45	50	19	33	PH-38	223	MSTP-38/35T
Hose 35x7	G 2 m	86	42	50	24	30	PH-35	526	MSTP-50/35T
Hose 42x7	G 1 1/2 m	86	50	50	20	38	PH-42	246	MSTP-42T
Hose 42x7	G 2 m	87	50	50	25	38	PH-42	452	MSTP-50/42T
Hose 50x9	G 2 m	91	59	55	25	41	PH-50	497	MSTP-50T



Mortar Couplings

made of Aluminium, Type Size X25, rigid and swivelling



- Couplings made of aluminium, optional rigid or swivelling
- Mainly used at the spraying device
- 60 % weight reduction compared to version made of malleable iron, therefore essentially easier operation in continuous use
- Swivelling version made of three parts, lead in teflon slide, absolutely leakage-proof for long lifetime
- Swivelling version allows permanent floating of mostly rigid mortar hoses for much easier handling in the respective application

Materials

- Coupling: Aluminium
- Handle: Malleable iron zinc-plated and yellow passivated (free of chrome VI)
- Seals: NBR, PTFE, PUR*

Max. Working Pressure	Temperature	Thread	System	TÜV-certified	Media	
PN 40 bar	-40°C – +90°C	ISO 228	X25	all types	Mortar/concrete	1

Couplings with female thread

Thread connection	L	SW	B	Type-Size	ID	L1	Passage	Version	Weight	Type No.
G 1 f	72	41	70	X25	42	19	25	rigid	290	MIG 10-X25A
G 1 f	120	41	70	X25	42	21	23	swivelling	405	MIG 10-X25ADR*

Rubber rings Type No. MDR-X25 and handles Type No. MNH-630 (© page 245)

*Female thread sealing ring made of material polyurethane

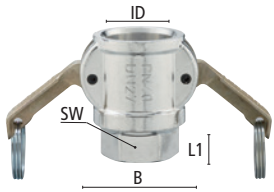

swivelling

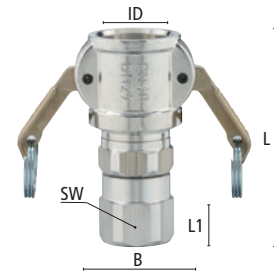

Mortar Couplings

made of Malleable Iron/ Steel - Interchangeable with System „Mai“

Materials

- Coupling, handle: Malleable iron zinc-plated and yellow passivated (free of chrome VI)
- Plug: Steel zinc-plated and yellow passivated (free of chrome VI)
- Seals: NBR

Max. Working Pressure	Temperature	Thread	Media	
PN 50 bar	-40°C – +90°C	ISO 228	Mortar/concrete	1

Coupling with female thread and 1 handle

Thread connection	L	SW	B	ID	L1	Passage	Weight	Type No.
G 1 f	70	41	55	38	16	25	375	MIG 10-MA

Rubber rings, type no. EDR-100-BU (☺ page 338)

Plug with female thread

Thread connection	L	SW	D	ID	L1	Passage	Weight	Type No.
G 1 f	80	41	46	37.5	18.5	25	405	VIG 10-MA

For hose connection use screwing stems for steel band (☺ page 243) or crimping ferrules (☺ page 245)

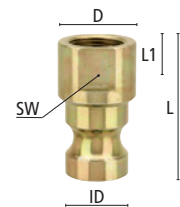
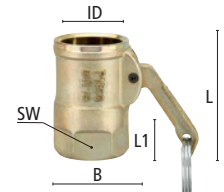

Sandblast Couplings



In blast machines and cabins as well as in stationary and mobile blast tools you usually work with sandblast couplings and nozzle holders.

This system is similar to the claw coupling - but it offers a claw distance with 58 mm. The head dimensions are always identical and interchangeable.

Advantages:

- High-quality materials
- Robust, reliable and durable
- Simple and fast handling
- Increased safety due to various safety systems
- Different sizes and connection types
- Matching nozzle holder and sandblast throttle valve

Reliable Connections for Aggressive Abrasive Media

In the case of sandblast couplings, the hoses are assembled in the coupling - they are fixed from the outside by means of holding screws. This prevents direct contact and faster abrasion of the fittings by aggressive blasting media.

It is also important to choose safety systems (DSR) in coupled mode.



Tried and Tested Design for Best Functionality

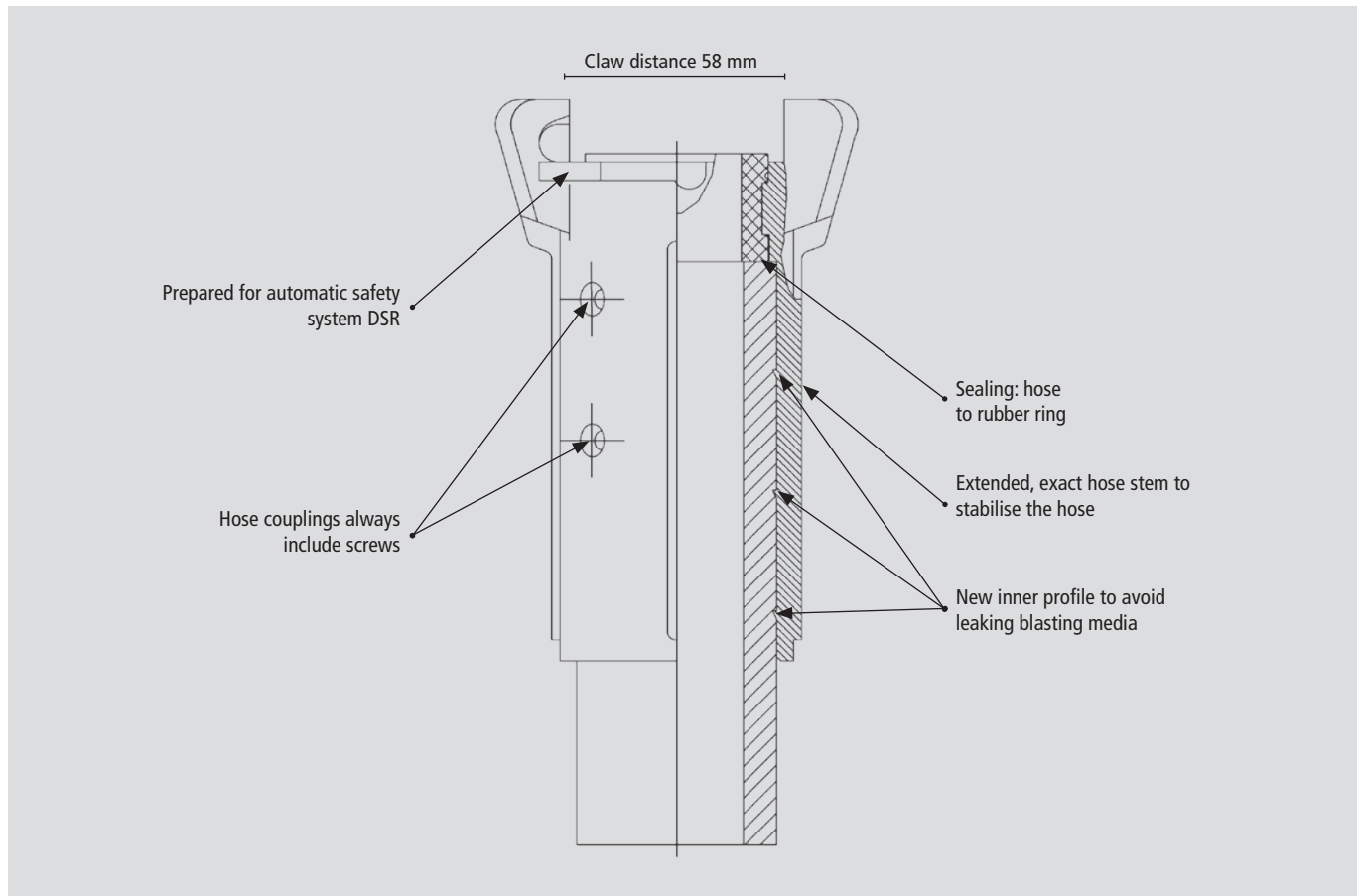

Two Materials - One Quality Promise

LUDECKE sandblast couplings are available in two materials. The robust malleable cast iron couplings are often applied in extreme conditions. The nylon couplings, on the other hand, are chosen for their light weight. The range also includes nozzle holders and sandblast throttle valves.

Sandblast Coupling Malleable Iron	Sandblast Coupling Nylon	Nozzle Holder Aluminium	Nozzle Holder Nylon	Sandblast Throttle Valve
--------------------------------------	-----------------------------	----------------------------	------------------------	-----------------------------



Materials					
Body:	Malleable iron (zinc-pl. + yellow pass.)	Nylon	Aluminium	Nylon	Malleable iron (zinc-pl. + yellow pass.)
Seals:	NBR	NBR	NBR	NBR	-
Throttle:	-	-	-	-	Steel hardened
Handle:	-	-	-	-	Malleable iron (zinc-pl. + yellow pass.)
Max. Working Pressure:	PN 12 bar	PN 12 bar	PN 12 bar	PN 12 bar	PN 10 bar
Temperature:	up to + 100°C	up to + 100°C	up to + 100°C	up to + 100°C	- 15°C - + 80°C
Thread types:	ISO 228/ Coarse thread	ISO 228/ Coarse thread	ISO 228/ Coarse thread	ISO 228/ Coarse thread	NPT
Claw distance:	58 mm	58 mm	-	-	-
Page:	250	251	250	251	251

Sandblast Couplings and Nozzle Holders

made of Malleable Iron/ Aluminium

- Sandblast couplings made of malleable iron zinc-plated and yellow passivated (free of chrome VI) or nylon
- Nozzle holders made of aluminium or nylon
- Hose couplings and nozzle holders always with screws
- For your own security, we recommend in all cases to use our safety-clip USC-1 and for all types 'TN' to use the automatic safety system DSR (for nylon couplings always inclusive)
- Types 'TN' with sealing hose to gasket and extended stem with new inner profile to avoid leaking blasting media
- **To be used at blasting machines and cabins, stationary and mobile blast tools**

Materials

- Couplings: Malleable iron zinc-plated and yellow passivated (free of chrome VI) or nylon
- Nozzle Holder: Aluminium or nylon
- Seals: NBR

Max. Working Pressure	Temperature	Thread	Claw distance	Media	
PN 12 bar	up to +100°C	ISO 228 / Coarse thread	58 mm	Blasting media	1



Couplings made of malleable iron with hose connection

Hose connection	L	B	Weight	Type No.
Hose 19x6	100	63	900	SS 19 T*
Hose 25x7	93	87	481	SS 25 T
Hose 32x8	92	87	570	SS 32 T
Hose 38x9	129	87	784	SS 38 T
Hose 40x10	150	87	893	SS 40 T

*KIG 54 (claw distance 42 mm) with screwed-in steel pipe

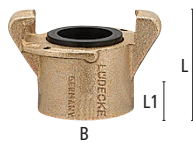

Couplings made of malleable iron with female thread

Thread connection	L	B	L1	Weight	Type No.
G 1 1/4 f	62	87	28.5	509	SK 38 TN
G 1 1/4 f	55	87	27	392	SK 38 T
G 1 1/2 f	62	87	28.5	464	SK 38/15 TN
G 1 1/2 f	55	87	27	340	SK 38/15 T
Coarse thread 50	62	87	27	448	SK 50 TN
Coarse thread 50	55	87	29.5	324	SK 50 T
G 2 f	84	87	42.5	550	SK 60 T



Original Rubber Ring for couplings made of malleable iron

Syst.	Resistance	L	D	D1	Material	Temp.°C	Colour	Shore A		Weight	Type No.
...T	Oil/ Air	10.5	48.5	31	NBR	-40 - +95	black	60°	10	11	SKD
...TN	Oil/ Air	27	44	31	NBR	-40 - +95	black	60°	10	20	SKD-1



Nozzle Holders made of aluminium with female thread

Hose connection	Thread connection	L	D	L1	Weight	Type No.
Hose 32x8	G 1 1/4 f	130	57	28.5	248	SD 32-32 A
Hose 32x8	Coarse thread 50	130	57	28.5	231	SD 50-32 A

Original Spare Parts for couplings and nozzle holders

Typ	Material	Characteristics	L	B		Weight	Type No.
Screw	Steel zinc-plated	rec.head 4.2 x 13	-	-	50	1	SHS
Safety Clip DIN 11024	Steel zinc-plated	wire Ø 3	63	27	50	10	USC-1
Automat. Safety System	Steel zinc-plated	wire Ø 2	-	-	10	6	DSR

Sandblast Couplings and Nozzle Holders

made of Nylon

Couplings made of Nylon with hose connection

Hose connection	L	B	Weight	Type No.
Hose 19x7	110	51	193	CQP-3/4
Hose 25x7	110	51	165	CQP-1
Hose 32x8	136	60	222	CQP-2
Hose 38x9	136	67	244	CQP-3
Hose 42x9	136	71	215	CQP-4



Couplings made of Nylon with female thread

Thread connection	L	B	Weight	Type No.
G 1 1/4 f	63	61	126	CFP
Coarse thread 50 mm	63	61	107	CPF-50

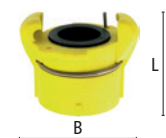

Original Rubber Rings for couplings made of Nylon

System	Resistance	L	D	D1	Material	Temp. °C	Colour	Shore A	Weight	Type No.
CQP-3/4	Oil/ Air	27	44	19	NBR	-40 – +95	black	60°	20	SDR-1
CQP-1	Oil/ Air	27	44	25	NBR	-40 – +95	black	60°	17	SDR-2
Other types	Oil/ Air	27	44	31.5	NBR	-40 – +95	black	60°	18	SDR-3

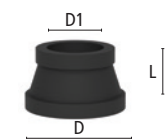

Nozzle Holders made of Nylon with female thread

Hose connection	Thread connection	L	D	Weight	Type No.
Hose 19x7	Coarse thread 50	100	49	115	NHP-34
Hose 25x7	Coarse thread 50	100	51	93	NHP-1
Hose 32x8	Coarse thread 50	120	59	150	NHP-2
Hose 38x9	Coarse thread 50	128	66	156	NHP-3
Hose 19x7	G 1 1/4 f	100	51	109	HEP-34
Hose 25x7	G 1 1/4 f	100	51	102	HEP-1
Hose 32x8	G 1 1/4 f	128	59	154	HEP-2
Hose 38x9	G 1 1/4 f	128	66	166	HEP-3



Sandblast Throttle Valve

with lever stop

- Sandblast throttle valve made of malleable iron zinc-plated and yellow passivated (free of chrome VI)
- Extreme robust version with throttle made of steel

Materials

- Housing, handle: Malleable iron zinc-plated and yellow passivated (free of chrome VI)

Max. Working Pressure	Thread	Media	
PN 50 bar	NPT	Mortar/concrete	1

Sandblast Throttle Valve with lever stop, without exhaust, both sides NPT male threads

Inlet	Outlet	L	SW	B	L1	L2	Passage	Weight	Type No.
NPT 1 m	NPT 1 m	96	37	168	22	22	16	741	ADA 10 SK

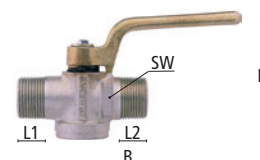

Hose Clamps and Hose Clips



For hose assembly of fittings, different assembly methods from strong clamps to light clips can be used subject to application, media, pressure or hose material.

Selection criteria are:

- Safety of the assembly
- Solvability
- Quickness
- Necessary devices (e.g. crimping machine)
- Cleanliness/ risk of injury (e.g. protruding screws)

Advantages:

- High-quality materials
- Robust, reliable and durable
- Easy handling
- Different sizes and versions
- Extremely safe connection due to hose clips with spacers and safety claws
- Can be reused at any time

Hose Clamps - Standard Version

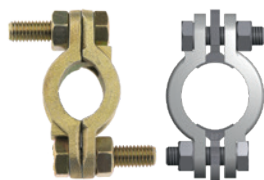

Hose Clamps - US-Version



Double-Ear Hose Clips



Materials	Hose Clamps - Standard Version	Hose Clamps - US-Version	Double-Ear Hose Clips
Clamps:	Malleable iron zinc-plated and yellow passiv./ Stainl. Steel 1.4401	Malleable iron zinc-plated and yellow passivated	Unbreakable special reliable steel zinc-plated & blue chromated
Spacers:	Malleable iron zinc-plated and yellow passiv./ Stainl. Steel 1.4401	-	-
Screws:	Steel zinc-plated/ Stainl. Steel A4-70	Steel zinc-plated	-
Max. Working Pressure:	PN 16/ 25 bar	PN 25 bar	-
Norm:	DIN 20039 A/B	-	-
Page:	253	254	254

Hose Clamps

Standard Version (DIN 20039 A/B)

- Robust clamps made of malleable iron zinc plated and yellow passivated (free of chrome VI) or stainless steel 1.4401
- Robust, easy and secure hose assembly for various fittings and applications

Materials

- Clamps, spacers: Malleable iron zinc-plated and yellow passivated (free of chrome VI)/ Stainless Steel 1.4401
- Screws: Steel zinc-plated/ Stainless Steel A4-70

Max. Working Pressure	Norm
PN 16 / 25 bar	DIN 20039 A/B

Hose Clamps made of malleable iron, two parts with overlapping cast-on-spacers

Hose-o.D./		L	B	Screw size		Weight	Type No.
Version	Range						
Hose i.D. 13	17-22	60	17	M 8x30	10	95	S 22



Hose Clamps DIN 20039 A made of stainless steel 1.4401, two parts with loose spacers

Hose-o.D./		L	B	Screw size		Weight	Type No.
Version	Range						
Hose i.D. 13	18-26	63	18	M 8x30	5	140	SLE 13
Hose i.D. 19	26-33	71	18	M 8x30	5	160	SLE 19
Hose i.D. 25	32-40	81	18	M 10x35	5	210	SLE 25

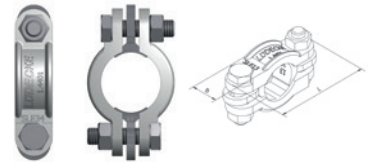

Hose Clamps DIN 20039 A made of malleable iron, two parts with loose spacers

Hose-o.D./		L	B	Screw size		Weight	Type No.
Version	Range						
Hose i.D. 13	22-29	63	18	M 8x30	10	128	SL 29*
Hose i.D. 19	28-34	71	18	M 8x30	10	134	SL 34*
Hose i.D. 25	32-40	81	18	M 10x35	10	188	SL 40*
Hose i.D. 32	39-49	91	20	M 10x35	10	244	SL 49*
Hose i.D. 38	48-60	108	24	M 10x45	5	297	SL 60*
Hose i.D. 50	56-72	116	25	M 10x50	5	340	SL 72
Hose i.D. 50	60-76	127	25	M 10x50	5	405	SL 76
Hose i.D. 63	77-94	146	30	M 12x55	5	556	SL 94
Hose i.D. 75	89-101	139	25	M 12x110	1	665	SL 400
Hose i.D. 75	94-115	176	35	M 12x65	1	739	SL 115
Hose i.D. 89	113-127	170	27	M 12x110	1	890	SL 525
Hose i.D. 89	115-145	198	38	M 12x80	1	1046	SL 145
Hose i.D. 100	127-140	178	28	M 12x110	1	972	SL 550
Hose i.D. 100	135-155	194	27	M 12x110	1	984	SL 600
Hose i.D. 125	155-175	217	30	M 12x125	1	1130	SL 675
Hose i.D. 150	175-195	244	30	M 12x125	1	1445	SL 769
Hose i.D. 175	210-225	280	35	M 16x150	1	2163	SL 875
Hose i.D. 200	227-250	312	35	M 16x150	1	2610	SL 988

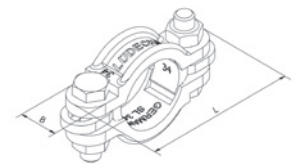

*according to DIN 20039 A

Hose Clamps DIN 20039 B made of malleable iron, two parts with loose spacers and safety claws***

Hose-o.D./		L	B	Screw size		Weight	Type No.
Version	Range						
Hose i.D. 13	22-29	63	18	M 8x30	10	142	SK 29
Hose 19x2		63	18	M 8x30	10	140	SK 29 FL**
Hose i.D. 19	28-32	77	21	M 10x35	10	220	SK 34
Hose 25x2		77	21	M 10x35	10	220	SK 34 FL**
Hose i.D. 25	35-42	90	22	M 10x35	10	272	SK 39
Hose i.D. 28	42-45	98	24	M 10x35	5	340	SK 44
Hose i.D. 35	45-53	108	25	M 10x45	5	380	SK 51
Hose i.D. 42	55-60	119	26	M 10x45	1	416	SK 60
Hose i.D. 50	60-73	132	30	M 12x55	1	637	SK 73
Hose i.D. 75	86-102	160	28	M 12x55	1	860	SK 75

**for flat hose

***PN 25 bar



Hose Clamps

US-Version

- Hose clamps made of malleable iron zinc plated and yellow passivated (free of chrome VI)
- **Robust, easy and secure hose assembly for various fittings and applications**

Materials

- Clamps: Malleable iron zinc-plated and yellow passivated (free of chrome VI)
- Screws: Steel zinc-plated

Max. Working Pressure

PN 25 bar

US-Version Hose Clamps, two parts with safety claws

Hose-o.D./

Version	Range	L	B	Screw size	Screws		Weight	Type No.
Hose i.D. 13	21-27	45	55	M 8x35	2	10	171	LB-4
Hose i.D. 19	30-35	43	65	M 8x45	2	10	176	SKA 34
Hose i.D. 19	30-33	64	70	M 10x50	2	1	405	LBU-9
Hose i.D. 19	33-38	70	71	M 10x50	2	1	413	LB-9
Hose i.D. 19	38-43	68	78	M 10x60	2	1	433	LB-10
Hose i.D. 25	34-45	70	85	M 10x50	2	1	500	SKA 10
Hose i.D. 50	63-70	100	120	M 12x80	4	1	1503	LBU-29

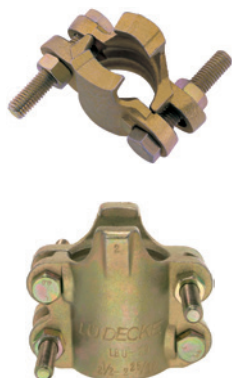

Double-Ear Hose Clips

- Clips made of special reliable steel zinc plated and blue chromated (free of chrome VI)
- Easy and fast assembly with pincer
- Concentric and strong clamp-effect, safe and unsolvable
- No risk of injury
- **To assemble hoses and fittings for various media**

Materials

- Clips: Unbreakable special reliable steel, zinc-plated and blue chromated (free of chrome VI)



100

Double-Ear Hose Clips

Hose-o.D./ Range	B	Weight	Type No.
5-7	5.5	1	ZOS 5-7
7-9	6	2	ZOS 7-9
9-11	6	2	ZOS 9-11
11-13	6	3	ZOS 11-13
13-15	7	4	ZOS 13-15
14-17	7.5	4	ZOS 14-17
15-18	8	5	ZOS 15-18
17-20	8	5	ZOS 17-20
19-21	7	5	ZOS 19-21
20-23	9	8	ZOS 20-23
22-25	9	9	ZOS 22-25
23-27	9	9	ZOS 23-27
25-28	9	10	ZOS 25-28
27-31	9	12	ZOS 27-31
31-34	9	13	ZOS 31-34
34-37	9	16	ZOS 34-37
37-40	9	17	ZOS 37-40
40-43	9	18	ZOS 40-43

Special assembly pincer	L	H	Weight	Type No.
	220	50	332	ZOSZ

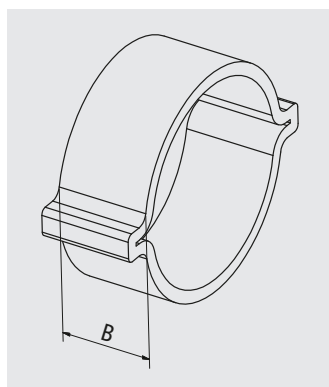

Ball Valves and Throttle Valves



LUDECKE ball and throttle valves are used as shut-off valves in pipe systems.

In ball valves, a ball serves as shut-off device in the fitting. It opens and closes the fitting with a 90-degree rotation. Due to the full passage only small losses of flow occur. Specific O-rings which are attached between the ball and the body provide sealing.





In throttle valves, a cone shaped throttle will be pressed against the body under pressure. In this way, the valve seals without any seal wear (almost no dead space in the passageway). When turning off, pressure is reduced by ventilating the output side. This allows for safe disconnection.

Advantages:

- High-quality materials
- Robust, reliable, absolutely leakage-proof and durable
- Easy and fast handling
- Different sizes, version and connection types

Broad Range

At **LUDECKE** you will get the necessary ball valves and throttle valves for various application areas.

	Ball Valves Sturdy-Version	Ball Valves Light-Version	Double Ball Valves and Airhammer Ball Valves	Throttle Valves Standard-Version	Throttle Valves US-Version
Materials					
Body:	Brass CW617N	Forged brass nickel-pl.	Brass CW617N	Malleable iron zinc-plated + yellow pass.	Malleable iron zinc-plated + yellow pass.
Sockets:	Brass CW617N	Forged brass nickel-pl.	Brass CW617N	-	-
Spindle and nut:	Brass MS 58 nickel-pl.	Brass MS 58 nickel-pl.	Brass MS 58 plain	-	-
Ball:	Brass MS 58 chromed	Brass MS 58 chromed	Brass MS 58 chromed	-	-
Seals:	PTFE*/FKM**	PTFE*/FKM**	PTFE glass fiber reinf.*/NBR**	NBR/ Brass	NBR
Handle:	Die-cast aluminium red/black lacquered	Steel zinc-plated and coated with red PVC	Steel red lacquered	Malleable iron zinc-plated + yellow pass.	Malleable iron zinc-plated + yellow pass.
Max. Working Pressure:	PN 35 bar	see diagram	PN 35 bar	PN 10 bar	PN 10 bar
Temperature:	-15°C – + 100°C	-15°C – + 120°C	-15°C – + 100°C	-15°C – + 80°C	-15°C – + 80°C
Thread:	DIN EN 10226	ISO 228	ISO 228	ISO 228	NPT, ANSI / ASME B1.20.1
Page:	256	256	257	258	259

*ball seals / **spindle seals

Ball Valves

Sturdy Version made of Brass Nickel-Plated

- High-quality ball valves used for air, water, colour, solvents etc.
- Maintenance-free operation, long-living, sturdy and reliable, easy switching with full free passage, tested to be leakproof
- For Industry, construction and civil installations

Materials

- Body and Sockets: Brass CW617N sandblasted and nickel-plated
- Spindle and nut: Brass MS 58 nickel-plated
- Ball: Brass MS 58 chromed
- Ball seals: PTFE
- Spindle seals: FKM
- Handle: Die-cast aluminium red/ black lacquered

Max. Working Pressure	Temperature	Thread	Media	
PN 35 bar	-15°C – +100°C	DIN EN 10226	various	1

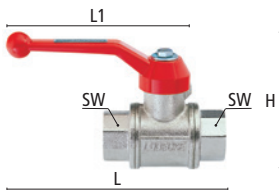

Ball Valves with female thread DIN EN 10226

Thread connection	L	SW	H	L1	Passage	Weight	Type No.
2 x R 1/4 f	50	25	78	95	8	296	KM 14 T
2 x R 3/8 f	60	25	78	95	10	302	KM 38 T
2 x R 1/2 f	75	26	82	95	15	390	KM 12 T
2 x R 3/4 f	80	32	90	104	20	682	KM 34 T
2 x R 1 f	90	39	97	104	25	876	KM 10 T
2 x R 2 f	140	70	170	178	50	3700	KM 20 T

Ball Valves

Light Version made of Brass Nickel-Plated

- Ball Valves with full passage and smaller sizes
- For construction, industry, craftsmanship, agriculture or civil installations

Materials

- Body and Sockets: Forged brass nickel-plated
- Spindle and nut: Brass MS 58 nickel-plated
- Ball: Brass MS 58 chromed
- Ball seals: PTFE
- Spindle seals: FKM
- Handle: Steel zinc-plated and coated with red PVC

Max. Working Pressure	Temperature	Thread	Passage	Pressure drop	Media	
⊕ Diagram	-15°C – +120°C	ISO 228	⊕ Diagram	⊕ Diagram	various	1

Ball Valves with female thread ISO 228

Thread connection	L	H	D	L1	Passage	Weight	Type No.
2 x G 1/4 f	46	48	24	85	8	150	K 14 K
2 x G 3/8 f	46	48	24	85	10	132	K 38 K
2 x G 1/2 f	50	40	30	85	15	180	K 12 K
2 x G 3/4 f	58	48	38	105	20	306	K 34 K
2 x G 1 f	68	52	46	105	25	470	K 10 K
2 x G 1 1/4 f	80	63	58	130	32	813	K 54 K
2 x G 1 1/2 f	93	69	70	130	40	1262	K 15 K
2 x G 2 f	110	83	86	165	50	2100	K 20 K
2 x G 2 1/2 f	133	116	111	260	65	3799	K 25 K
2 x G 3 f	156	127	135	260	80	5625	K 30 K

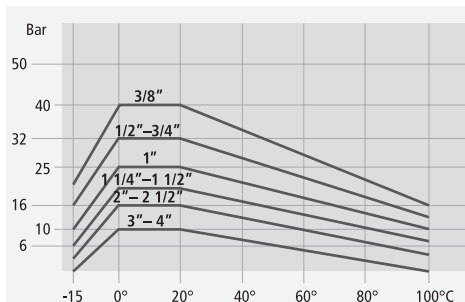
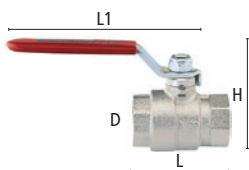

Pressure and temperature diagram

For each ball valve, the nominal pressure PN depends on the type size and the temperature or vice versa.

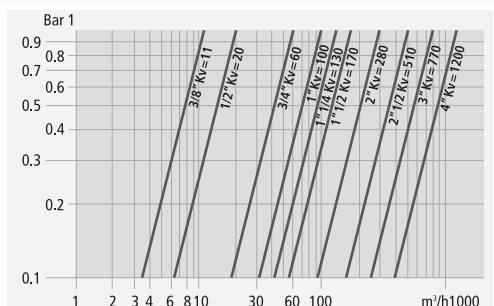

Port capacity and pressure drop diagram

The Kv is the flow rate, expressed in cubic meters per hour, at a pressure drop of 1 bar with water at 15°C.

Double Ball Valves and Airhammer Ball Valves

Sturdy Version made of Brass Plain

- High-quality, maintenance free and extremely robust valves made of brass
- With lever stop and ventilation, on request also without ventilation
- For compressed air supply in construction, at compressors and airhammers in the industry

Materials

- Body and Sockets: Brass CW617N
- Spindle and nut: Brass MS 58 plain
- Ball: Brass MS 58 chromed
- Ball seals: PTFE glass fiber reinforced
- Spindle seals: NBR
- Handle: Steel red lacquered

Max. Working Pressure	Temperature	Thread	Media	
PN 35 bar	-15°C – +100°C	ISO 228	Compressed air	1

Double Ball Valves

Connection*	Thread connection**	L	SW	H	Passage	Weight	Type No.
2 x G 3/4 m	G 1 f	115	41	105	13	1039	DKH 10
2 x KIGO 34	G 1 f	170	41	130	13	1350	DKH 10 G
2 x KIM 34	G 1 f	170	41	130	13	1435	DKH 10 M

Airhammer Ball Valves, inlet thread with locking nut SW 32, outlet with inside cone 1:4

Connection*	Thread connection**	L	SW	H	Passage	Weight	Type No.
G 3/4 m	G 3/4 m	81	32	82	13	491	BKH 34
KIM 34	G 3/4 m	120	32	82	13	684	BKH 34 M

- On request we produce valves according to your drawings or samples with special connections and seals.
- Also available with T-Handle up to DN 25 e.g. KM 34 TBG (surcharge of 3.62 Euro/ piece)
- Please order ball valves used in inspected plants separately, e.g. KM 12 T - AD (after TRB 404)

*Outlet

**Inlet

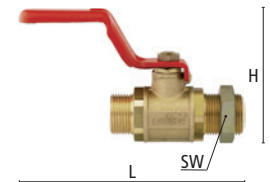
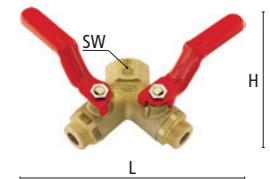

Throttle Valves

Standard Version

- Extremely robust valves made of malleable iron zinc-plated and yellow passivated (free of chrome VI)
- With brass throttle and handle made of malleable iron
- Self-sealing, a cone shaped throttle will be pressed against the body under pressure, so the valve seals without any seal wear
- With thread connections or claw couplings with rubber or brass seal
- When turning off, pressure is reduced by ventilating the output side. This allows for safe disconnection.
- For compressed air supply in construction at compressors, hose lines and air tools

Materials

- Body, handle: Malleable iron zinc-plated and yellow passivated (free of chrome VI)
- Seals: NBR / Brass

Max. Working Pressure	Temperature	Thread	Claw distance	Media	
PN 10 bar	-15°C – +80°C	ISO 228	42 mm	Compressed Air	1

Single Valves with lever stop and exhaust

Inlet	Outlet	L	SW	B	Passage	Version	Seal	Weight	Type No.
G 1/2 f	G 3/4 m	77	41	100	15	without coupling		660	EH 12
G 3/4 f	G 3/4 m	70	41	100	17	without coupling		610	EH 34
G 1 f	G 3/4 m	70	41	100	17	without coupling		565	EH 10
G 1/2 f	KIGO 34	112	41	100	15	rigid claw coupling	NBR	819	EHG 12
G 3/4 f	KIGO 34	100	41	100	17	rigid claw coupling	NBR	761	EHG 34
G 1 f	KIGO 34	100	41	100	17	rigid claw coupling	NBR	726	EHG 10
G 1/2 f	KIM 34	122	41	100	15	rigid claw coupling	Brass	859	EHM 12
G 3/4 f	KIM 34	115	41	100	17	rigid claw coupling	Brass	808	EHM 34
G 1 f	KIM 34	115	41	100	17	rigid claw coupling	Brass	759	EHM 10
G 3/4 f	KIG 34-DR	130	41	100	17	swivelling claw coupling	NBR	943	EHG 34-DR

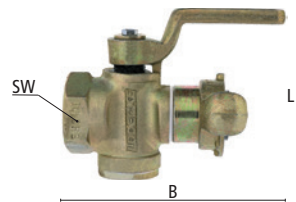

swivelling

Double Valves with lever stop and exhaust

Inlet	Outlet	L	SW	B	Passage	Version	Seal	Weight	Type No.
G 3/4 f	2 x G 3/4 m	92	41	118	17	without coupling		1146	DH 34
G 1 f	2 x G 3/4 m	92	41	118	17	without coupling		1100	DH 10
G 3/4 f	2 x KIGO 34	92	41	170	17	rigid claw coupling	NBR	1466	DHG 34
G 1 f	2 x KIGO 34	92	41	170	17	rigid claw coupling	NBR	1438	DHG 10
G 3/4 f	2 x KIM 34	92	41	180	17	rigid claw coupling	Brass	1545	DHM 34
G 1 f	2 x KIM 34	92	41	180	17	rigid claw coupling	Brass	1503	DHM 10
G 3/4 f	2 x KIG 34-DR	92	41	225	17	swivelling claw coupling	NBR	1816	DHG 34-DR

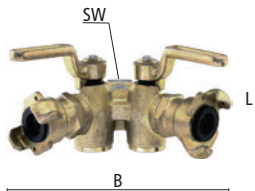

swivelling

Straight Way Valves without lever stop, without exhaust, on request with exhaust

Inlet	Outlet	L	SW	B	L1	Passage	Weight	Type No.
G 1/2 f	G 1/2 f	85	37	128	18	16	700	DU 12
G 3/4 f	G 3/4 f	85	41	134	16	16	820	DU 34
G 1 f	G 1 f	85	41	134	16	16	770	DUL 10
G 1 f	G 1 f	107	43	132	18	20	1150	DUS 10

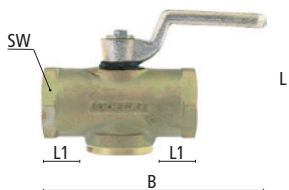

Airhammer Valves DIN 20030 without lever stop, without exhaust, inlet thread with locking nut SW 32/41

Inlet	Outlet	L	SW	B	L1	L2	SW1	Passage	Weight	Type No.
G 3/4 m	G 3/4 m, Cone 1:4	82	32	107	34	17	32	13	632	BH 343
G 3/4 m	Rd 32x1/8 m, Cone 1:3	82	32	135	34	17	32	13	773	BH 3486
G 1 m	G 1 m, Cone 1:3	85	36	120	40	22	36	16	848	BH 106
G 1 m	Rd 32x1/8 m, Cone 1:3	85	36	120	40	22	36	16	834	BH 326

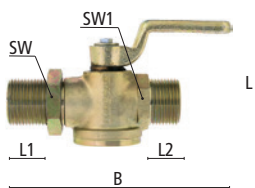

Throttle Valves

US Version

- Extremely robust valves made of malleable iron zinc-plated and yellow passivated (free of chrome VI)
- With brass throttle and handle made of malleable iron
- Self-sealing, a cone shaped throttle will be pressed against the body under pressure, so the valve seals without any seal wear
- With NPT-thread connections or US-claw couplings with rubber seal
- When turning off, pressure is reduced by ventilating the output side. This allows for safe disconnection.
- For compressed air supply in construction at compressors, hose lines and air tools

Materials

- Body, handle: Malleable iron zinc-plated and yellow passivated (free of chrome VI)
- Seals: NBR

Max. Working Pressure	Temperature	Thread	Claw distance	Media	
PN 10 bar	-15°C – +80°C	NPT, ANSI / ASME B1.20.1	41 mm	Compressed Air	1

US-Double Valves with lever stop and exhaust

Inlet	Outlet	L	SW	B	Passage	Version	Seal	Weight	Type No.
NPT 3/4 f	NPT 2 x 3/4 m	92	41	118	17	without coupling		1170	DHA 34
NPT 1 f	NPT 2 x 3/4 m	92	41	118	17	without coupling		1130	DHA 10
NPT 3/4 f	2 x KIA 34	92	41	190	17	rigid claw coupling	NBR	1570	DHGA 34
NPT 1 f	2 x KIA 34	92	41	190	17	rigid claw coupling	NBR	1530	DHGA 10

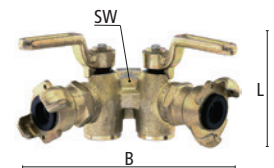

US-Straight-Way Valves without lever stop, without exhaust, on request with exhaust

Inlet	Outlet	L	SW	B	L1	Passage	Weight	Type No.
NPT 1/2 f	NPT 1/2 f	80	32	80	16	13	530	ADI 12
NPT 3/4 f	NPT 3/4 f	96	41	95	17	16	905	ADI 34
NPT 1 f	NPT 1 f	96	41	95	18	16	850	ADI 10

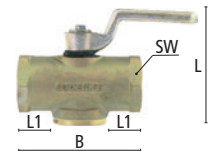

US-Straight-Way Valves without lever stop, without exhaust, on request with exhaust

Inlet	Outlet	L	SW	B	L1	Passage	Weight	Type No.
NPT 1/2 m	NPT 1/2 m	80	25	85	17	13	430	ADA 12
NPT 3/4 m	NPT 3/4 m	96	37	93	18	16	700	ADA 34
NPT 1 m	NPT 1 m	96	37	92.5	22	16	750	ADA 10

